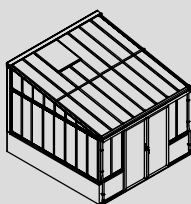
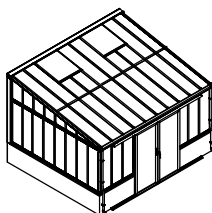
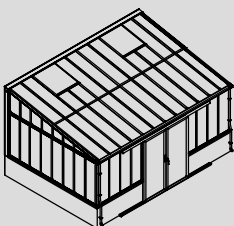
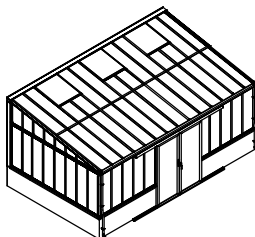
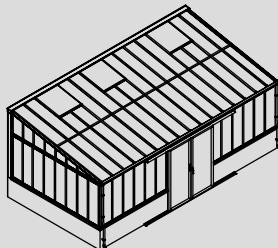

Green Room®

BY WILLAB GARDEN

				
3281-FD	3282-FD	3283-FD	3284-FD	3285-FD
314 × 320 × 267 cm	389 × 320 × 267 cm	464 × 320 × 267 cm	539 × 320 × 267 cm	614 × 320 × 267 cm

Product size (L×W×H):

Storlek (L×B×H):

Størrelse (L×B×H):

Størrelse (L×B×H):

Koko (P×L×K):

Please read carefully before assembling.
Two people are needed.







Läs noggrant innan montering.
Det krävs två personer för montering.

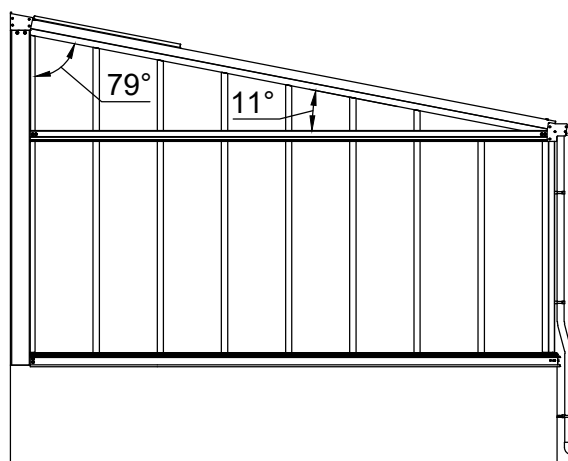









Læs venligst omhyggeligt, før montering.
Der kræves to personer til montering.

Les monteringsanvisningen nøye innen montering.
Det kreves to personer for montering.





















































Lue ohjeet huolellisesti läpi ennen asentamista.
Asentamiseen tarvitaan kaksi henkilöä.











































































Part	3281		3282		3283		3284		3285		QTY.	Code	Page
	NO.	Length(MM)	NO.	Length(MM)	NO.	Length(MM)	NO.	Length(MM)	NO.	Length(MM)			
	40L-Y62-4-11	3134	40L-Y62-5-11	3885	40L-Y62-6-11	4636	40L-Y62-7-11	5387	40L-Y62-8-11	6138	1	A003	P4
	40LA-Y63-4-11	3157	40LA-Y63-5-11	3908	40LA-Y63-6-11	4659	40LA-Y63-7-11	5410	40LA-Y63-8-11	6161	1	A004	P5
	40LA-Y26A-4	3157	40LA-Y26A-5	3908	40LA-Y26A-6	4659	40LA-Y26A-7	5410	40LA-Y26A-8	6161	1	A005	P6
	40LA-Y26B-4	2899	40LA-Y26B-5	3650	40LA-Y26B-6	4401	40LA-Y26B-7	5152	40LA-Y26B-8	5903	1	A006	P6
	40LA-Y28A-4	3157	40LA-Y28A-5	3908	40LA-Y28A-6	4659	40LA-Y28A-7	5410	40LA-Y28A-8	6161	1	A007	P6
	40LA-Y28B-4	2917	40LA-Y28B-5	3668	40LA-Y28B-6	4419	40LA-Y28B-7	5170	40LA-Y28B-8	5921	1	A008	P6

Part	NO.	QTY.				Length(MM)	Page	Part	NO.	QTY.				Length(MM)	Page		
		3281	3282	3283	3284					3285	3281	3282	3283			3284	3285
	40X-P80E-B	1	2	2	3	3	801	P5		40X-Y81E	2	4	4	6	6	882	P25
	40A-Y30	8	9	10	11	12	1235	P7									
	40L-Y33R-11	1	2	2	3	3	3079	P9									
	40L-Y33L-11	1	2	2	3	3	3079	P9									
	40L-Y33A-11	1	0	1	0	1	3079	P9									
	40A-Y01	10	11	12	13	14	1235	P11									
	40L-Y06-11	5	6	7	8	9	3118	P15									
	40L-Y07	1	2	2	3	3	713	P15									
	40X-P80E-A	1	2	2	3	3	791	P25									































												1a/30	
--	--	--	--	--	--	--	--	--	--	--	--	--------------	--



Part	NO.	QTY.	Length(MM)	Page	Part	NO.	QTY.	Length(MM)	Page
	40LA-Y20R-11	1	1960	P2		40X-Y04R-11A	1	124	P14
	40LA-Y20L-11	1	1960	P2		40L-Y04R-11	1	560	P14
	40A-Y20	2	1236	P3		40A-Y90	2	1866	P18
	40L-S60R	1	3023	P4		40A-Y91R	1	1866	P18
	40LA-S61L	1	3023	P4		40A-Y91L	1	1866	P18
	40LA-Y25A-11	2	1960	P6		40A-Y92R	1	769	P18
	40LA-Y25B-11	2	1911	P6		40A-Y92L	1	769	P18
	40LA-Y27A-11	2	1960	P6		40A-Y93	2	769	P18
	40LA-Y27B-11	2	1911	P6		40A-Y95	4	1765	P19
	40LA-Y30	2	1235	P7		40A-Y96	4	668	P19
	40L-Y31R-11	1	561	P8		40A-Y97R	1	1860	P21
	40L-Y31L-11	1	561	P8		40A-Y97-A	2	1851	P21
	40X-Y31R-11A	1	124	P8		40A-Y97L	1	1860	P21
	40X-Y31L-11A	1	124	P8		40A-Y94	1	1835	P21
	40X-Y31R-11B	1	270	P8		40A-Y98-R	1	1910	P22
	40X-Y31L-11B	1	270	P8		40A-Y98-L	1	1910	P22
	40X-Y31R-11C	1	416	P8		40A-Y99	1	1424	P22
	40X-Y31L-11C	1	416	P8		40A-Y100	1	1424	P22
	40L-Y21-11	1	3118	P8		40A-Y64	1	3016	P23
	40L-Y22-11	1	3118	P8		40A-Y17	1	3110	P23
	40A-Y02	2	1235	P11		40A-Y98A-R	1	1855	P23
	40LA-Y01	2	1235	P11		40A-Y98A-L	1	1855	P23
	40L-Y05L-11	1	3080	P13					
	40X-Y04L-11C	1	416	P13					
	40X-Y04L-11B	1	270	P13					
	40X-Y04L-11A	1	124	P13					
	40L-Y04L-11	1	560	P13					
	40L-Y05R-11	1	3080	P14					
	40X-Y04R-11C	1	416	P14					
	40X-Y04R-11B	1	270	P14					
				1b/30					

Part	NO.	QTY.					Length(MM)	Page
		3281	3282	3283	3284	3285		
	W06	6	10	10	14	14	46	P2~25
	Si6-16	84	92	100	108	116	PCS	P2~22
	J05	109	121	129	141	149	PCS	P2~27
	M6-8	30	32	34	36	38	PCS	P2~9
	J09	12	20	20	28	28	PCS	P2~26
	7C28-004	13	17	17	21	21	PCS	P4~23
	T07	2	4	4	6	6	PCS	P5
	PSJ10-80	18	20	20	22	22	PCS	P6
	DQ8-16	18	20	20	22	22	PCS	P6
	SW8-80	18	20	20	22	22	PCS	P6
	Si6-12	10	14	14	18	18	PCS	P7~27
	Si5-16	4	8	8	12	12	PCS	P9
	7B26-069	5	6	7	8	9	PCS	P15
	J13	6M	6M	6M	8M	8M		P15
	Z4.8-19	16	20	24	28	32	PCS	P15
	W04	20	24	24	28	28	PCS	P18~25
	7C26-007N	17.5M	18.3M	19M	19.8M	20.5M		P12~16
	7C26-038	3M	3M	3.8M	3.8M	4.5M		P16
	MCJT002	15.5M	19M	19M	22.5M	22.5M		P20~26
1c/30								







Part	NO.	QTY.	Length(MM)	Page	Part	NO.	QTY.	Length(MM)	Page
	7B26-025	4	PCS	P2		7C33-S02	2	PCS	P28
	PS8-80	12	PCS	P2		7C33-S03	4	PCS	P29
	7B26-017	2	PCS	P3		Z4.8-25	4	PCS	P29
	J08	1	PCS	P3~27		7C33-S04	2	PCS	P29
	7B26-077	2	PCS	P4		J07-A	2	PCS	P29
	M8-20	4	PCS	P4		J07-B	2	PCS	P29
	Si6-25	6	PCS	P5		7B26-074	1	PCS	P30
	7C26-031	10	PCS	P6~23		7B26-073	1	PCS	P30
	MF6	6	PCS	P7~8		7C26-039	2	PCS	P30
	7B26-068	2	PCS	P8		Za4.2-13	18	PCS	P30
	Si8-25	4	PCS	P8		7B26-076	1	PCS	P30
	7B33-020	8	PCS	P8		7B26-075	1	PCS	P30
	Si8-16	4	PCS	P8		7C26-040	2	PCS	P30
	W03	8	30	P18					
	Z4.2-13	16	PCS	P21~24		L06	2	1400	P4
	T04	2	PCS	P21		NSST120	1.9M		P21
	Z4.2-38	3	PCS	P21		7C26-S01A	2	1900	P29
	Z3.5-25	8	PCS	P21~24					
	M6-35	2	PCS	P22		TOOL-001	1	274	P2~30
	Si6-35	6	PCS	P22		TOOL-002	1	80	P2~30
	PS6-60	2	PCS	P22		TOOL-003A	1	2MM	P5~7
	Z4.2-50	5	PCS	P23		TOOL-004A	1	3MM	
	Si6-25	3	PCS	P23		TOOL-005	1	4MM	P2~27
	T01	1	PCS	P24		TOOL-006	1	5MM	P2~22
	T01A	1	PCS	P24		TOOL-007	1	6MM	P4
	J02	2	PCS	P24					
	7B26-039	2	PCS	P24					
	7B26-038	2	PCS	P24					
	M4-40	2	PCS	P24					
	Mi4-17	2	PCS	P24					







Spare Part Bag For Green Room Lean To WALL







Part	NO.	QTY.	Length(MM)	Page	Part	NO.	QTY.	Length(MM)	Page
	7B26-025	2	PCS	P2		Si5-16	4	PCS	P9
	Si6-16	8	PCS	P2~22		Z4.8-19	4	PCS	P15
	J05	8	PCS	P2~23		W04	4	PCS	P18~25
	M6-8	4	PCS	P2~9		Z4.2-13	4	PCS	P21~24
	J09	4	PCS	P2~26		Z4.2-38	2	PCS	P21
	M8-20	2	PCS	P4		Z3.5-25	2	PCS	P21~24
	7C28-004	4	PCS	P4~23		M6-35	2	PCS	P22
	T07	2	PCS	P5		Si6-35	2	PCS	P22
	Si6-25	2	PCS	P5		Z4.2-50	2	PCS	P23
	DQ8-16	4	PCS	P6		Si6-25	2	PCS	P23
	7C26-031	2	PCS	P6		M4-40	2	PCS	P24
	Si6-12	4	PCS	P7~27		Mi4-17	2	PCS	P24
	MF6	2	PCS	P7~8		Z4.8-25	2	PCS	P29
	Si8-25	2	PCS	P8		J07-A	2	PCS	P29
	7B33-020	2	PCS	P8		Za4.2-13	4	PCS	P30
	Si8-16	2	PCS	P8					





3043PA-S-4	Part	NO.	QTY.	Length(MM)	Page	Code
		40A-Y13L	1	854	P2	A009
		40A-Y13R	1	854	P2	A010
		40A-S11-4AR	1	749	P2	A011
		40A-S11-4AL	1	749	P2	A012
		40A-Y13L-A	1	779	P2	
		40A-Y13R-A	1	779	P2	
		40A-Y15-L	1	842	P11	A013
		40A-Y15-R	1	842	P11	A014





3171P-S-5D	Part	NO.	QTY.	Length(MM)	Page	Code
		50A-Y13R	1	1230	P2	A009
		50A-Y13L	1	1230	P2	A010
		40A-S11-5AR	1	1125	P2	A011
		40A-S11-5AL	1	1125	P2	A012
		50A-Y15-R	1	1218	P11	A013
		50A-Y15-L	1	1218	P11	A014
		40L-Y62A-5B	2	431	P17	A015

3171P-S-6D	Part	NO.	QTY.	Length(MM)	Page	Code
		40A-S11-6R	1	1605	P2	A009
		40A-S11-6L	1	1605	P2	A010
		40A-S11-6AR	1	1500	P2	A011
		40A-S11-6AL	1	1500	P2	A012
		40A-S15-6R	1	1593	P11	A013
		40A-S15-6L	1	1593	P11	A014
	40L-Y62A-6B	2	807	P17	A015	



	Part	NO.	QTY.	Length(MM)	Page	Code
3171P-S-7D		40A-S11-7R	1	1981	P2	A009
		40A-S11-7L	1	1981	P2	A010
		40A-S11-7AR	1	1876	P2	A011
		40A-S11-7AL	1	1876	P2	A012
		40A-S15-7R	1	1969	P11	A013
		40A-S15-7L	1	1969	P11	A014
		40L-Y62A-7B	2	1182	P17	A015

	Part	NO.	QTY.	Length(MM)	Page	Code
3171P-S-8D		40A-S11-8R	1	2356	P2	A009
		40A-S11-8L	1	2356	P2	A010
		40A-S11-8AR	1	2251	P2	A011
		40A-S11-8AL	1	2251	P2	A012
		40A-S15-8R	1	2344	P11	A013
		40A-S15-8L	1	2344	P11	A014
		40L-Y62A-8B	2	1558	P17	A015





















	Part	NO.	QTY.	Length(MM)	Page
3171P-S-BASE4R		40LA-Y12R	1	3098	P2
		40LA-Y12R-A	1	3023	P2
		40L-S15R-4	1	3086	P11
		40X-Y60-AN	1	3023	P17

	Part	NO.	QTY.	Length(MM)	Page
3171P-S-4F		40LA-Y12L	1	3098	P2
		40LA-Y12L-A	1	3023	P2
		40L-S15L-4	1	3086	P11
		40X-Y60-AN	1	3023	P17

3281P-S-1

Part	NO.	QTY.	Length(MM)	Page	Part	NO.	QTY.	Length(MM)	Page
	40A-Y30	10	1235	P7		7B26-011	26	PCS	P2~4
	40X-Y31R-11D	1	197	P8		Ma6-12	52	PCS	P2~8
	40X-Y31L-11D	1	197	P8		M6	52	PCS	P2~8
	40X-Y31R-11E	1	343	P8		7B26-062	7	PCS	P4~5
	40X-Y31L-11E	1	343	P8		Si6-16	66	PCS	P7~9
	40X-Y31R-11F	1	488	P8		J05	66	PCS	P7~9
	40X-Y31L-11F	1	488	P8		7B26-046R	3	PCS	P8
	40L-Y33B-11	1	2202	P9		7B26-046L	3	PCS	P8
	40L-Y34B	1	713	P9		M6-8	20	PCS	P8~9
	40L-Y33A-11	3	3079	P9		Si5-16	2	PCS	P9
	40L-Y36N3	2	335	P9		J01	2	PCS	P9
	40L-Y36N4	6	337	P9		7B26-069	4	PCS	P15
	40A-Y01	10	1235	P11		Z4.8-19	8	PCS	P15
	40X-Y04L-11D	1	197	P13					
	40X-Y04L-11E	1	343	P13					
	40X-Y04L-11F	1	489	P13					
	40X-Y04R-11D	1	197	P14					
	40X-Y04R-11E	1	343	P14					
	40X-Y04R-11F	1	489	P14					
	40L-Y06-11	3	3118	P15					
	40L-Y06A-11	1	2240	P15					
	40L-Y08N3	2	335	P15					
	40L-Y08N4	6	337	P15					
	40X-Y82E-A	1	801	P25					
						TOOL-009	1	341	P2~4
						TOOL-013	1	342	P4~5
						TOOL-014	1	352.5	P8

3281P-S-2

Part	NO.	QTY.	Length(MM)	Page	Part	NO.	QTY.	Length(MM)	Page
	40A-Y30	2	1235	P7		7B26-011	4	PCS	P2~4
	40L-Y33B-11	1	2202	P9		Ma6-12	10	PCS	P2~8
	40L-Y34B	1	713	P9		M6	10	PCS	P2~8
	40L-Y33A-11	1	3079	P9		7B26-062	3	PCS	P4~5
	40L-Y36N4	4	337	P9		Si6-16	14	PCS	P7~9
	40A-Y01	2	1235	P11		J05	14	PCS	P7~9
	40L-Y06-11	1	3118	P15		M6-8	4	PCS	P9
	40L-Y06A-11	1	2240	P15		Si5-16	2	PCS	P9
	40L-Y08N4	4	337	P15		J01	2	PCS	P9
	40X-Y82E-A	1	801	P25		7B26-069	2	PCS	P15
						Z4.8-19	4	PCS	P15

CTN NO.	QTY.				
	3281	3282	3283	3284	3285
3043PA-S-4	1	0	0	0	0
3171P-S-5D	0	1	0	0	0
3171P-S-6D	0	0	1	0	0
3171P-S-7D	0	0	0	1	0
3171P-S-8D	0	0	0	0	1
3171P-S-BASE4R	1	1	1	1	1
3171P-S-4F	1	1	1	1	1
3281P-S-1	1	1	1	1	1
3281P-S-2	0	1	1	2	2

Part	NO.	QTY.					Length(MM)	Page
		3281	3282	3283	3284	3285		
	354×1262	20	22	24	26	28	1262	P10
	620×134	2	2	2	2	2	620	P13~14
	354×207	2	2	2	2	2	354	P13~14
	354×280	2	2	2	2	2	354	P13~14
	354×353	2	2	2	2	2	354	P13~14
	354×426	2	2	2	2	2	426	P13~14
	354×499	2	2	2	2	2	499	P13~14
	354×572	2	2	2	2	2	572	P13~14
	353×1555	14	16	20	22	26	1555	P15
	353×674	2	4	4	6	6	674	P15
	659×1756	2	2	2	2	2	1756	P19
	782×863	1	2	2	3	3	863	P25

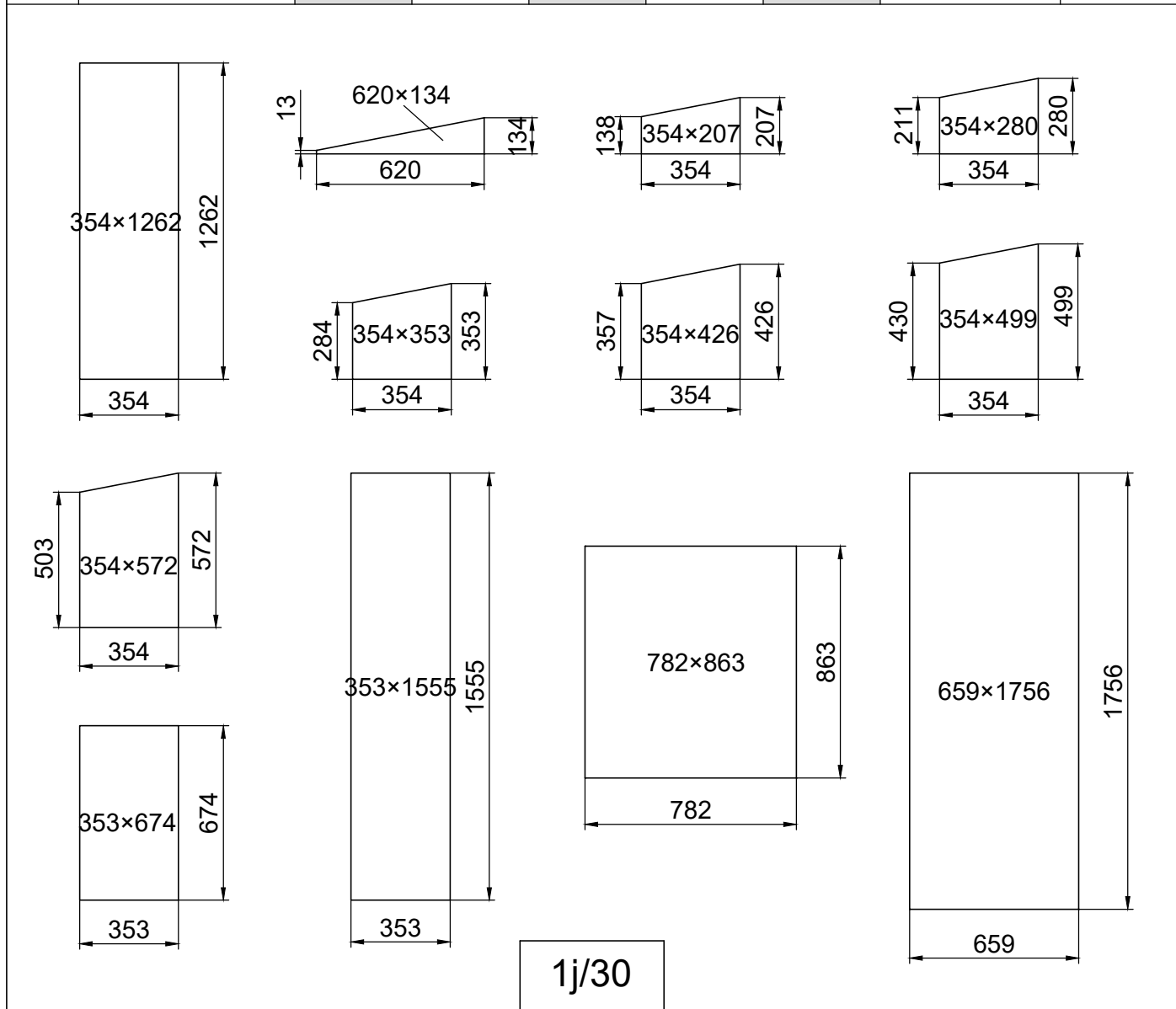

NO.	3181	3182	3183	3184	3185
L1	3139	3890	4641	5392	6143
L2	832	1208	1583	1959	2334
AREA	10.0 M ²	12.4 M ²	14.8 M ²	17.2 M ²	19.6 M ²

Sealing should be done to prevent frost from destroying the wall. The sealant between the wall and foundation of the greenroom is provided and handled by customers themselves.

Tätning bör göras för att muren ej skall frostsprängas. Tätning mellan mur och sockel står kunden själv för.

Tætningen bør gøres for at forhindre frostsprængninger i muren. Tætningen mellem mur og aluminiumprofil står kunden selv for

En tetning bør lages for å hindre frostsprengning av muren. Tetning mellom mur og sokkel ordnes av kunden selv

Tiivistys täytyy tehdä, jotta muuri ei hajoa pakkasella. Tiiviste muurin ja sokkelin välissä täytyy asiakkaan hoitaa itse

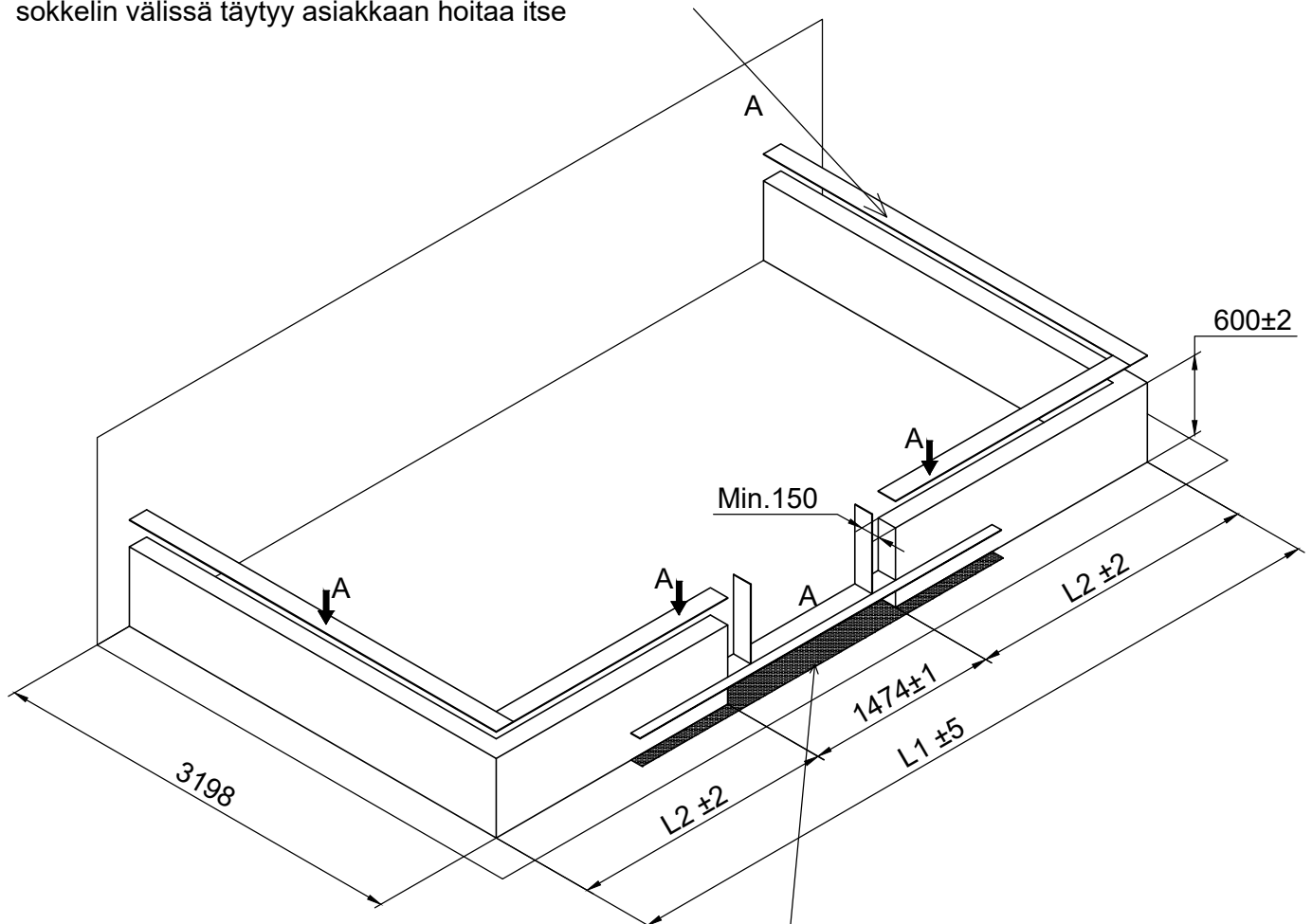

Make sure the floor below the doors frame should be flat and solid.

Se till att underlaget under dörrramen är plan och på solid grund.

Sørg for, at underlaget under dørkarmen er plan og på fast grund.

Sørg for at underlaget under dørterskelen er slett og på solid fundament.



Tarkista, että maa ovikarmin alla on sileä ja tasainen.

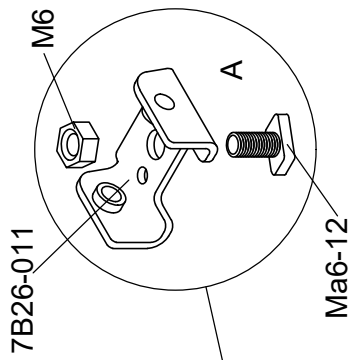
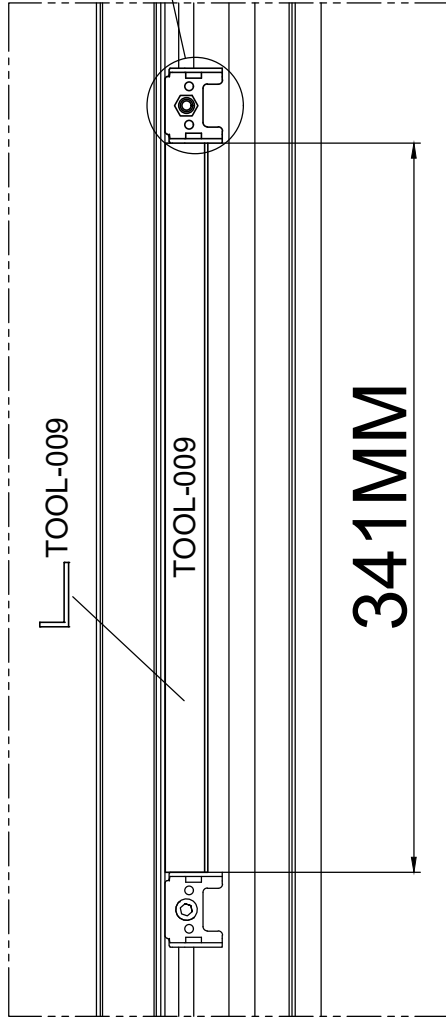
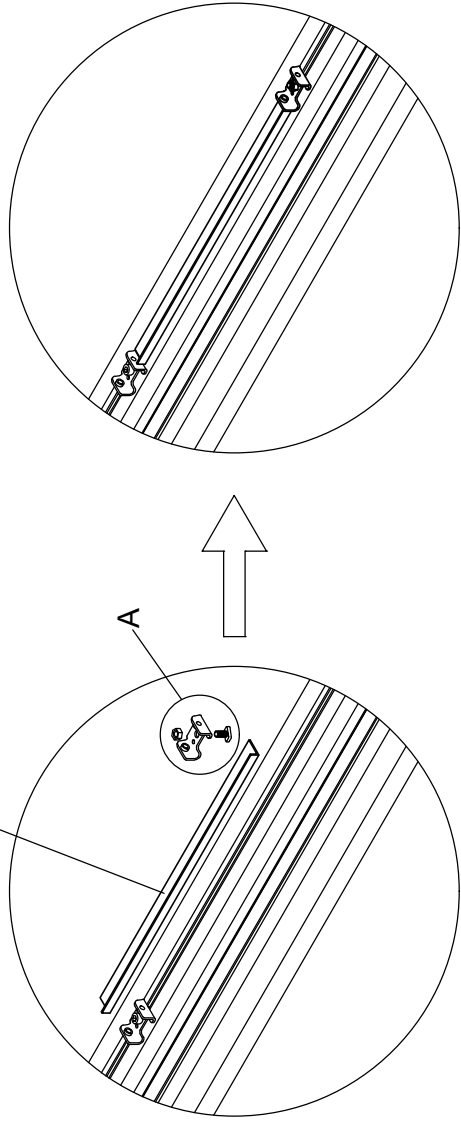

L TOOL-009(341MM)

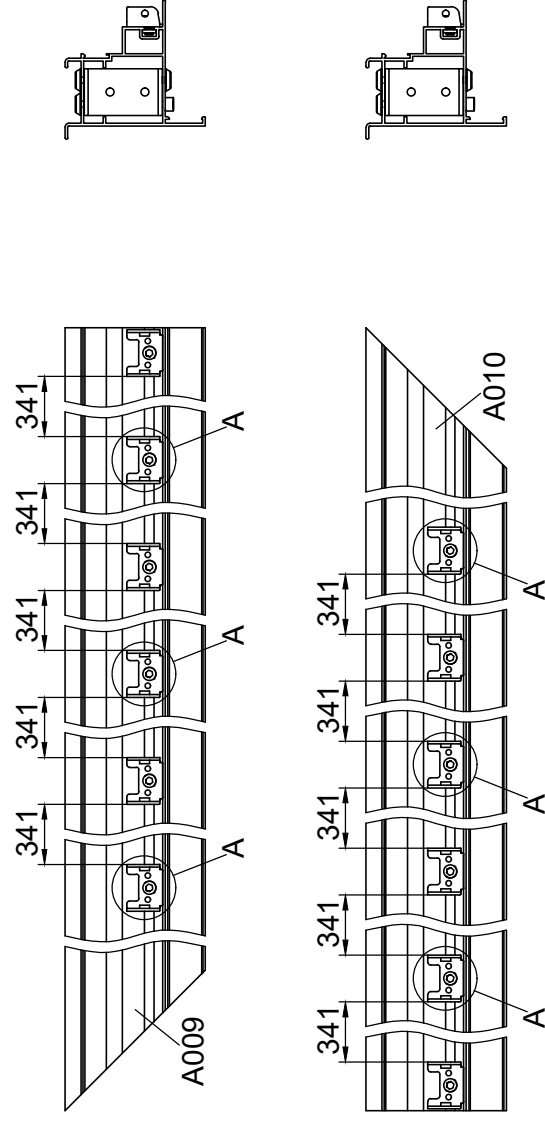
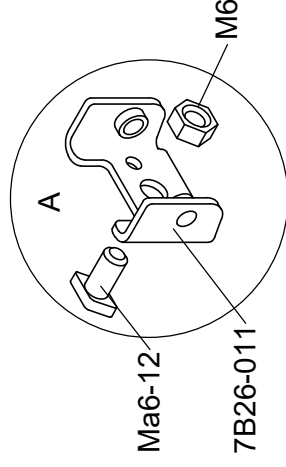

Part	Product	NO.	Length(MM)	QTY.	CTN NO.	Code	QTY.						Length (MM)		
							3281	3282	3274	3275	3276				
A	3281	40A-Y13R	854	1	3043PA-S-4	A009	3281P -S-1	3281P -S-2	3281P -S-1	3281P -S-2	3281P -S-1	3281P -S-2	3281P -S-1	3281P -S-2	
	3282	50A-Y13R	1230	1	3171P-S-5D		2	0	2	0	2	2	2	2	4
	3283	40A-S11-6R	1605	1	3171P-S-6D		2	0	2	0	2	2	2	2	4
	3284	40A-S11-7R	1981	1	3171P-S-7D		2	0	2	0	2	2	2	2	4
	3285	40A-S11-8R	2356	1	3171P-S-8D		2	0	2	0	2	2	2	2	4
A	3281	40A-Y13L	854	1	3043PA-S-4	A010	3281P -S-1	3281P -S-2	3281P -S-1	3281P -S-2	3281P -S-1	3281P -S-2	3281P -S-1	3281P -S-2	
	3282	50A-Y13L	1230	1	3171P-S-5D		2	0	2	0	2	2	2	2	4
	3283	40A-S11-6L	1605	1	3171P-S-6D		2	0	2	0	2	2	2	2	4
	3284	40A-S11-7L	1981	1	3171P-S-7D		2	0	2	0	2	2	2	2	4
	3285	40A-S11-8L	2356	1	3171P-S-8D		2	0	2	0	2	2	2	2	4



Part	NO.	Length (MM)	QTY.	CTN NO.
	40LA-Y12R	3098	1	3171P-S-BASE4R
	40LA-Y12L	3098	1	3171P-S-4F

Part	NO.	QTY.	Length(MM)	CTN NO.
	7B26-011	8	PCS	3281P-S-1
	Ma6-12	8	PCS	3281P-S-1
	M6	8	PCS	3281P-S-1

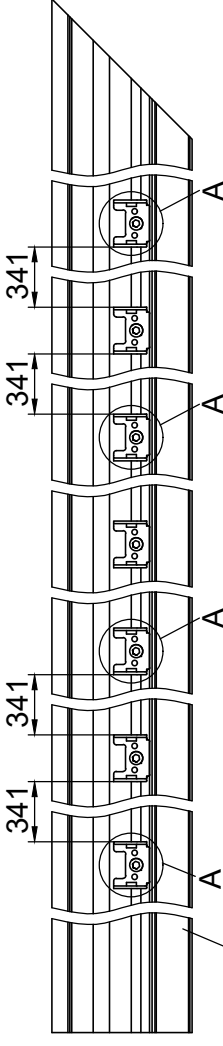

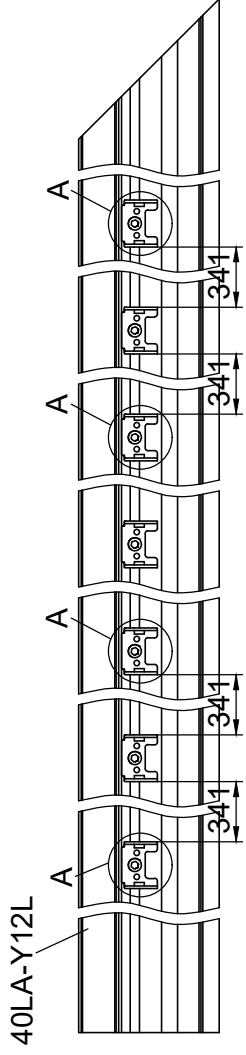

40LA-Y12R



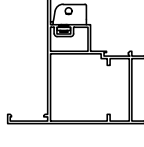
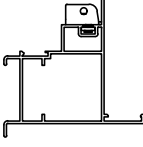
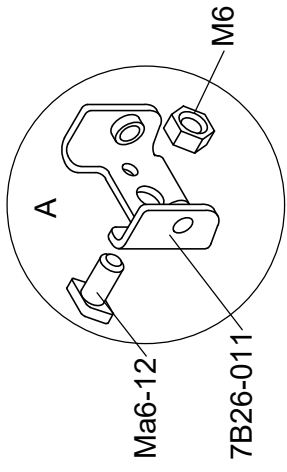



40LA-Y12L

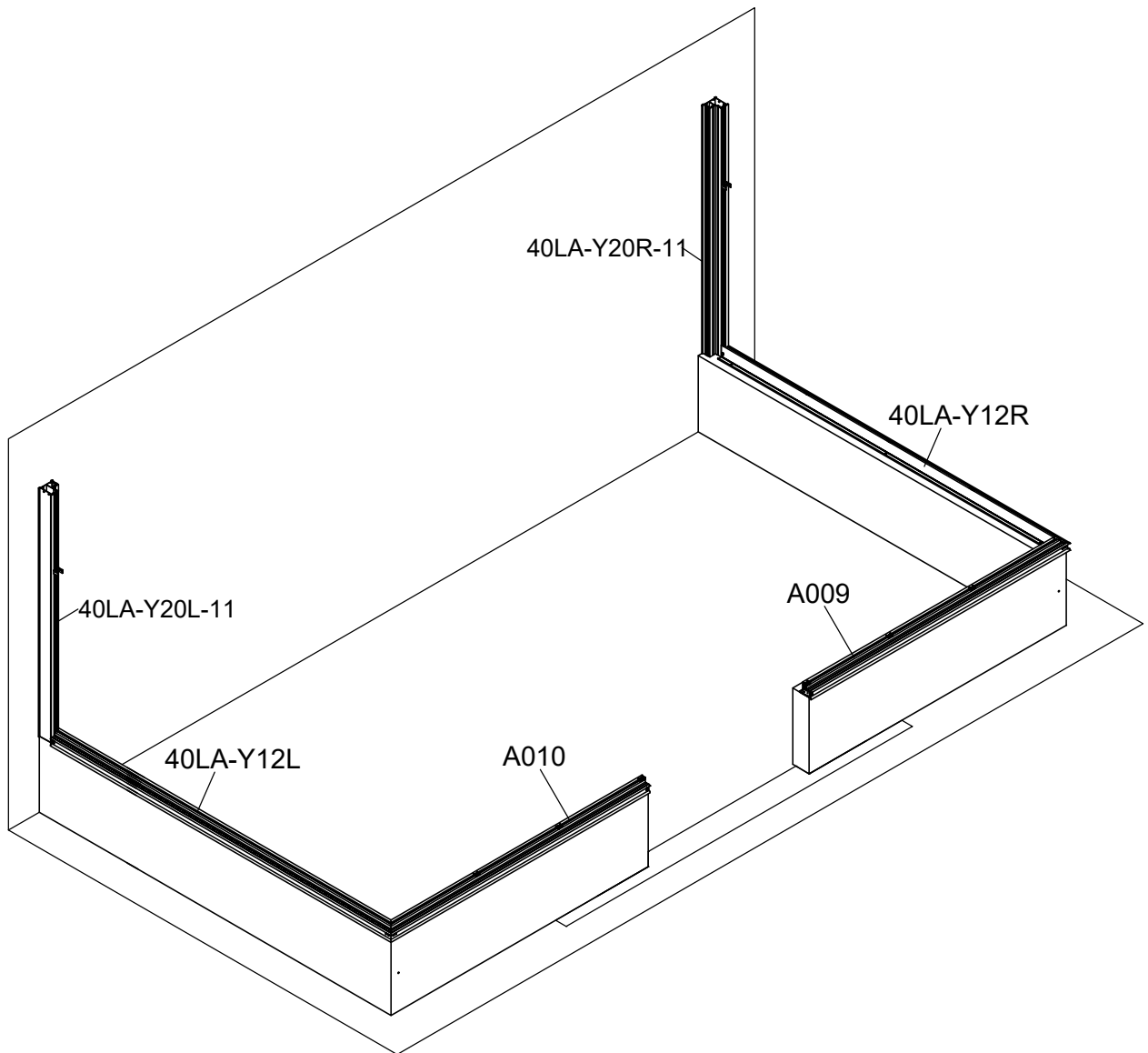



Part	NO.	QTY.	Length(MM)
	40LA-Y20R-11	1	1960
	40LA-Y20L-11	1	1960

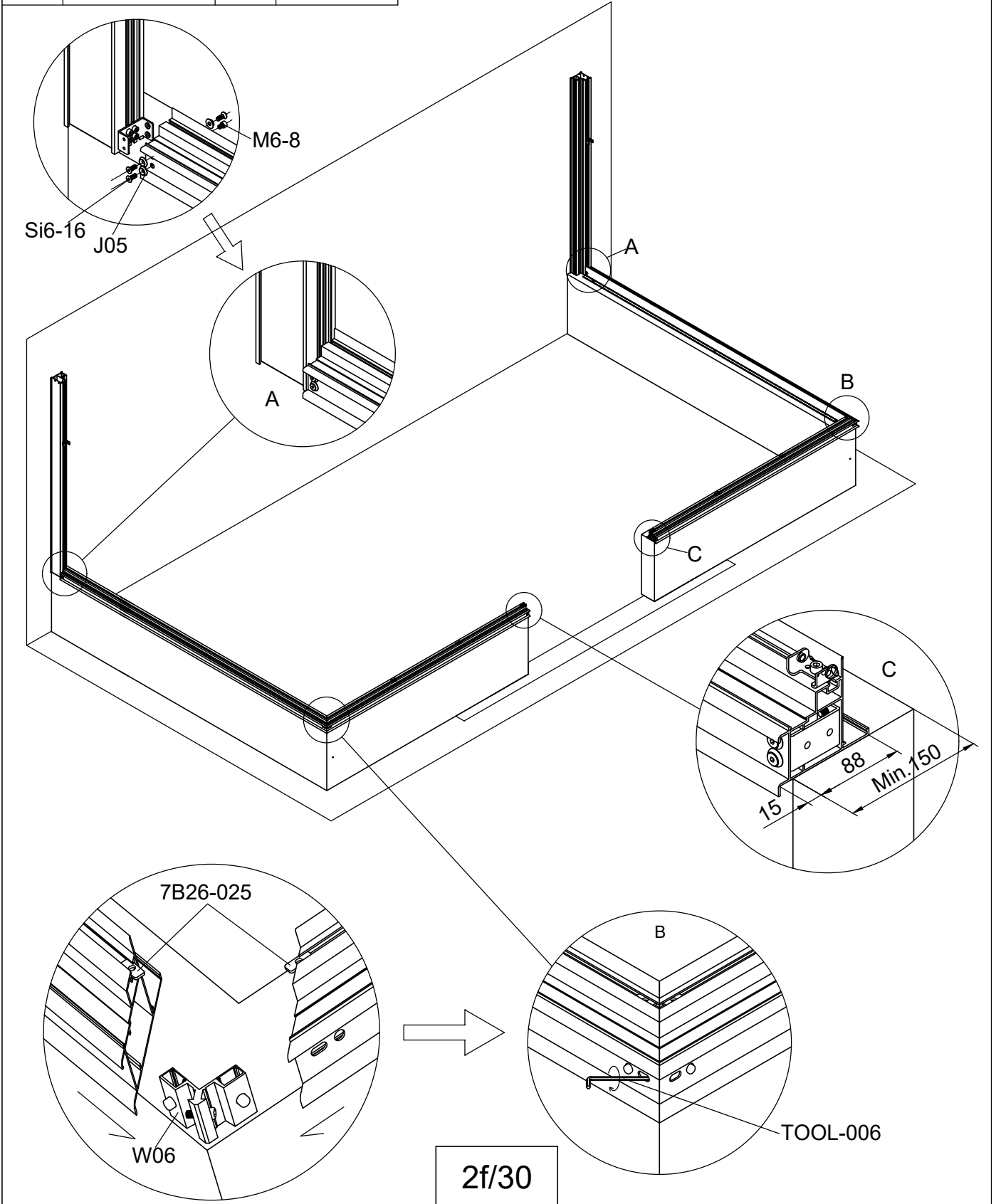

Part	NO.	QTY.	Length(MM)
	W06	2	46
	Si6-16	6	PCS
	J05	6	PCS
	M6-8	2	PCS
	7B26-025	4	PCS

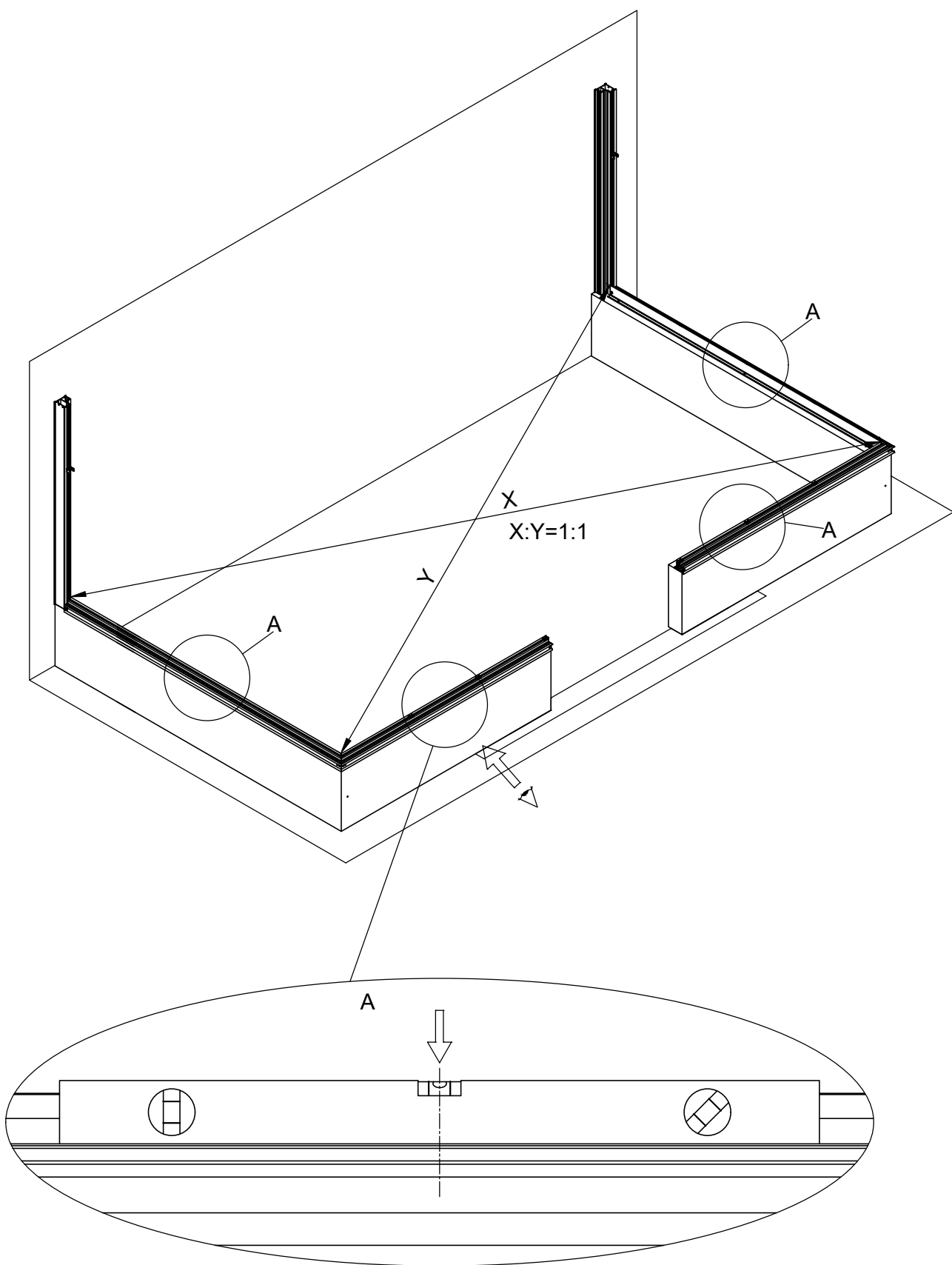



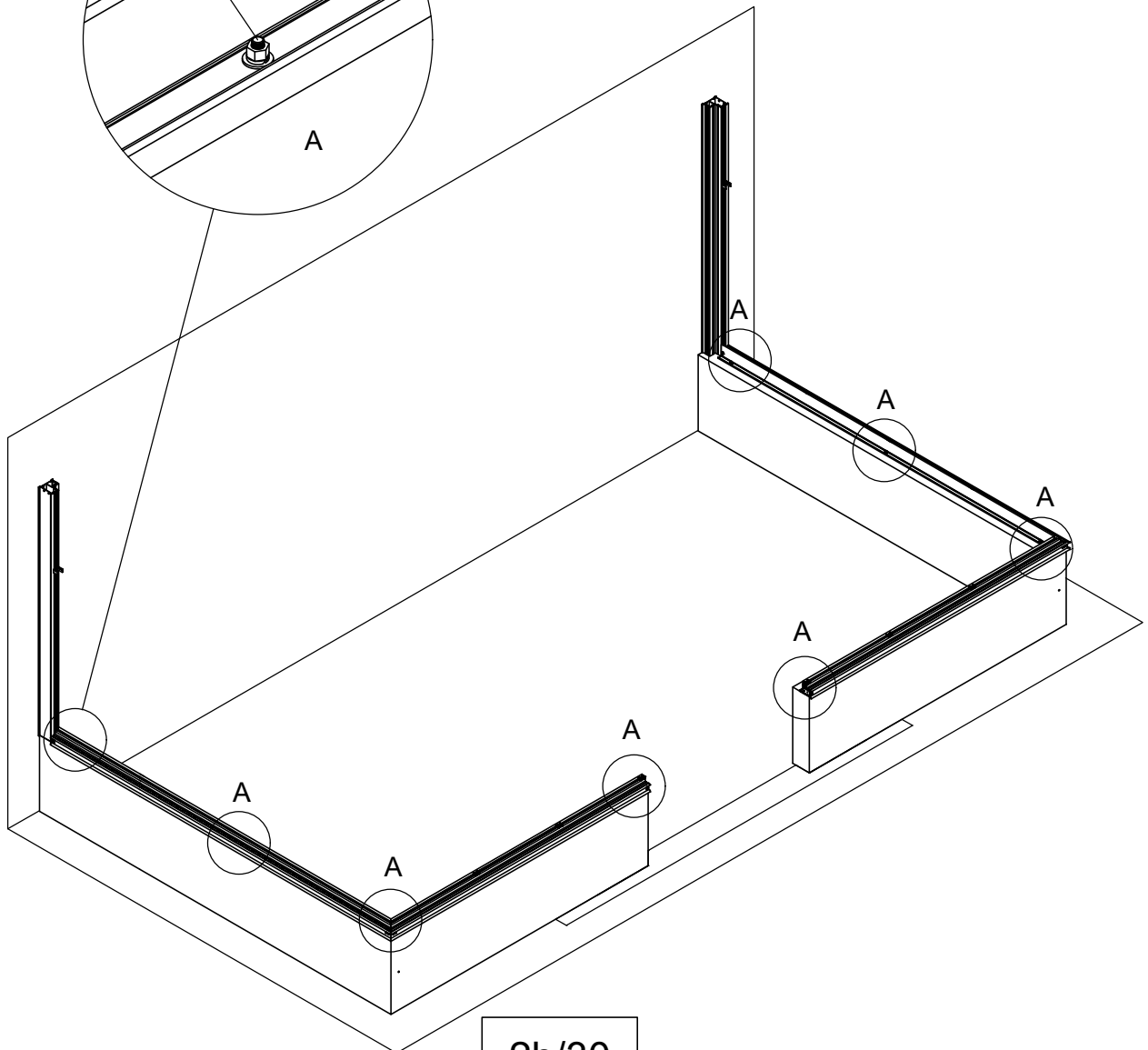
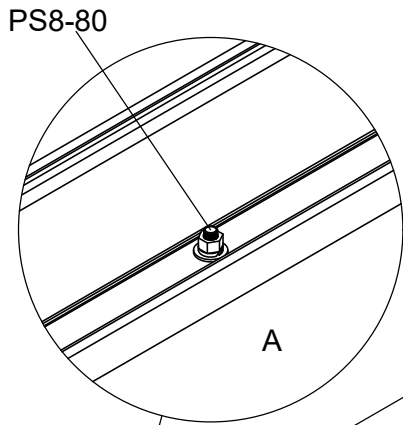
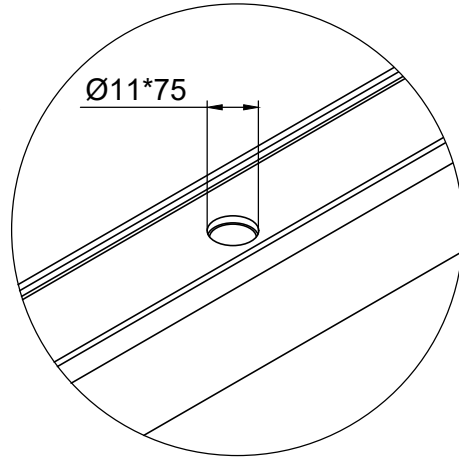
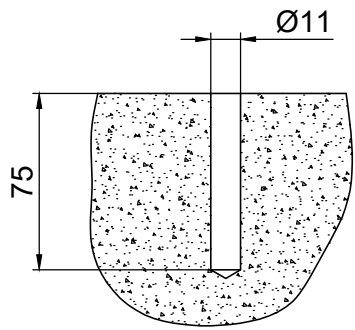

Part	NO.	QTY.	Length(MM)
	PS8-80	10	PCS





Part	Product	NO.	Length(MM)	QTY.	CTN NO.	Code
	3281	40A-S11-4AR	749	1	3043PA-S-4	A011
	3282	40A-S11-5AR	1125	1	3171P-S-5D	
	3283	40A-S11-6AR	1500	1	3171P-S-6D	
	3284	40A-S11-7AR	1876	1	3171P-S-7D	
	3285	40A-S11-8AR	2251	1	3171P-S-8D	
	3281	40A-S11-4AL	749	1	3043PA-S-4	A012
	3282	40A-S11-5AL	1125	1	3171P-S-5D	
	3283	40A-S11-6AL	1500	1	3171P-S-6D	
	3284	40A-S11-7AL	1876	1	3171P-S-7D	
	3285	40A-S11-8AL	2251	1	3171P-S-8D	



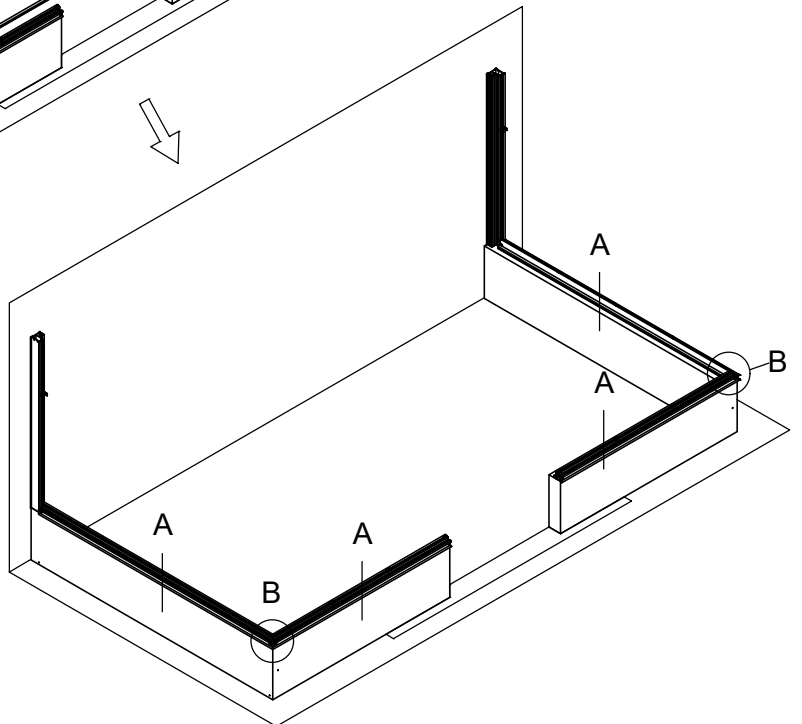
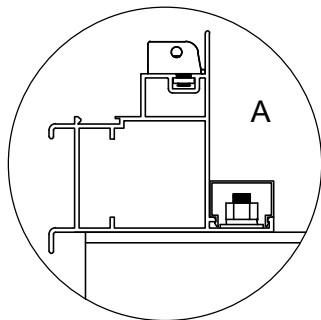
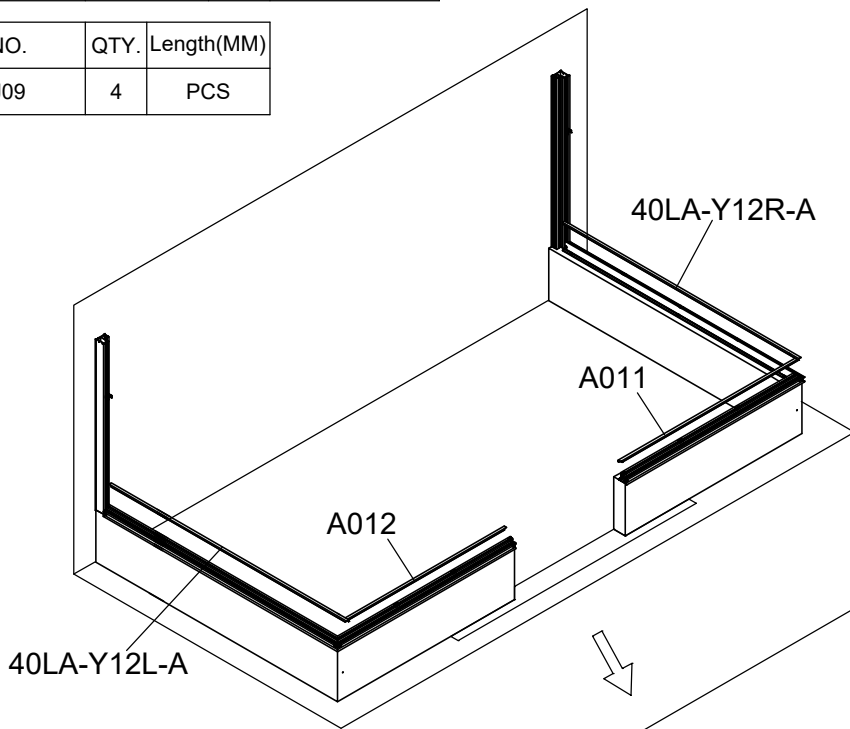
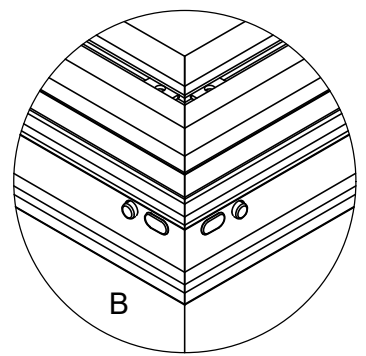
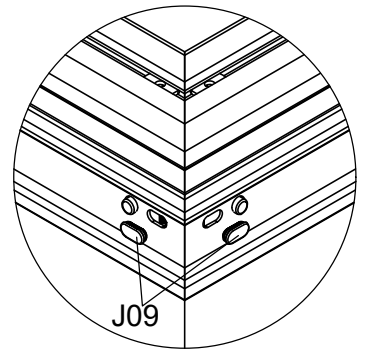

Part	NO.	Length(MM)	QTY.	CTN NO.
	40LA-Y12R-A	3023	1	3171P-S-BASE4R
	40LA-Y12L-A	3023	1	3171P-S-4F

Part	NO.	QTY.	Length(MM)
	J09	4	PCS

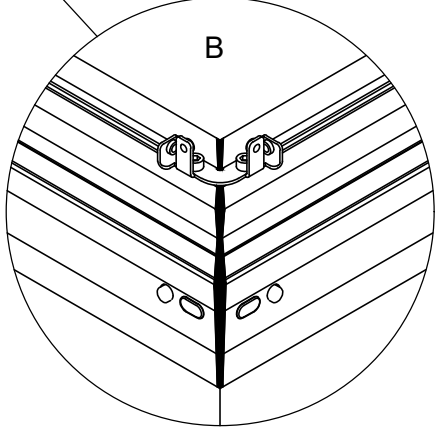
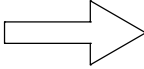
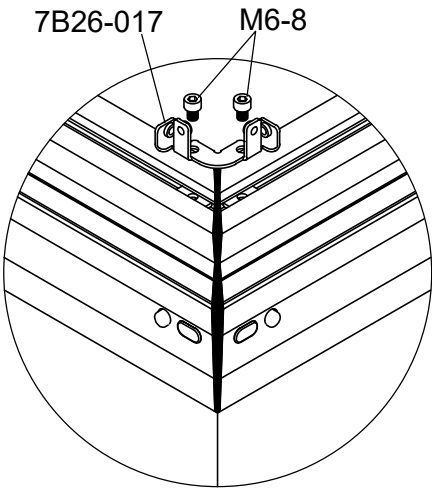
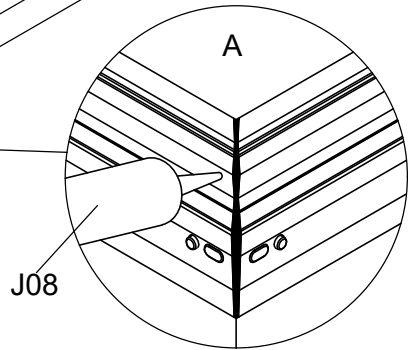
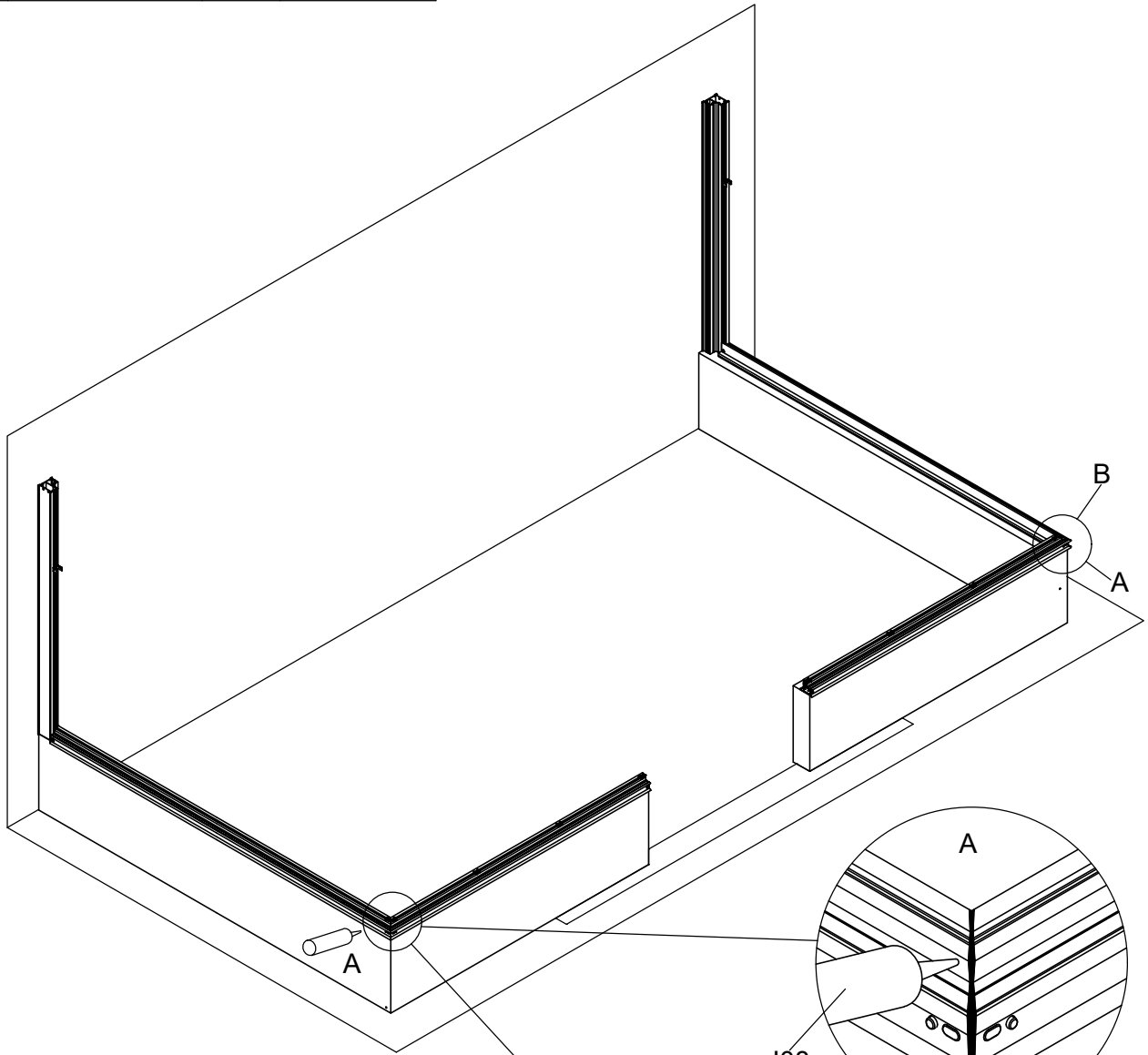





Part	NO.	QTY.	Length(MM)
	7B26-017	2	PCS
	M6-8	4	PCS
	J08	1	PCS

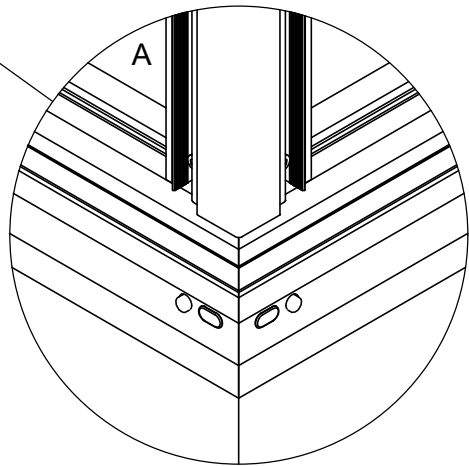
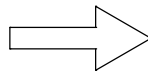
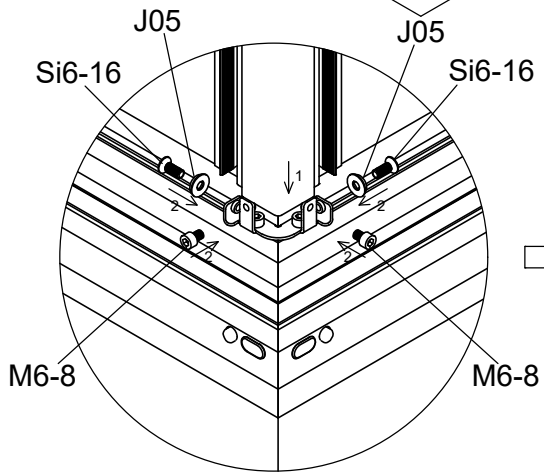
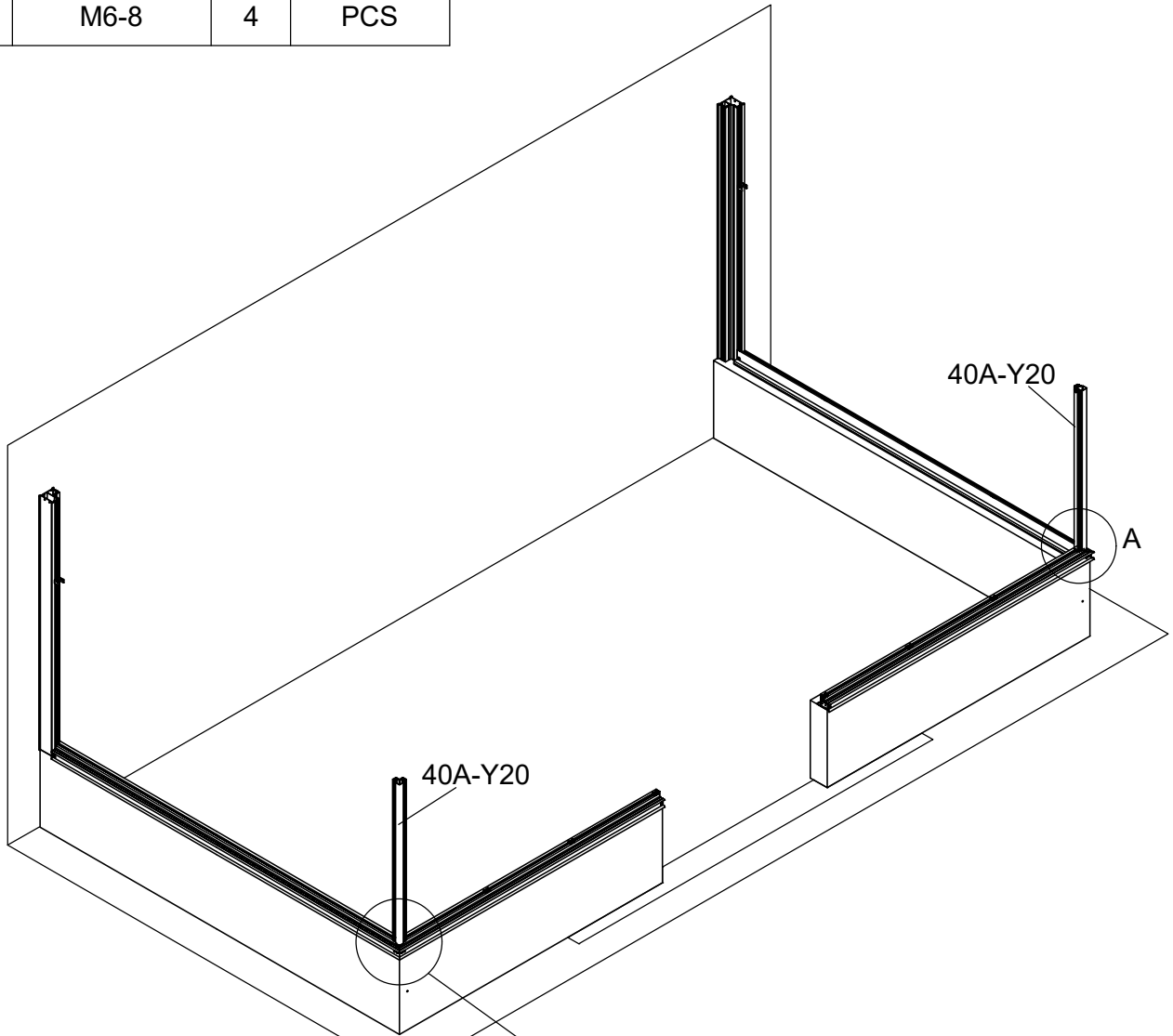

Part	NO.	QTY.	Length(MM)
	40A-Y20	2	1236
	Si6-16	4	PCS
	J05	4	PCS
	M6-8	4	PCS



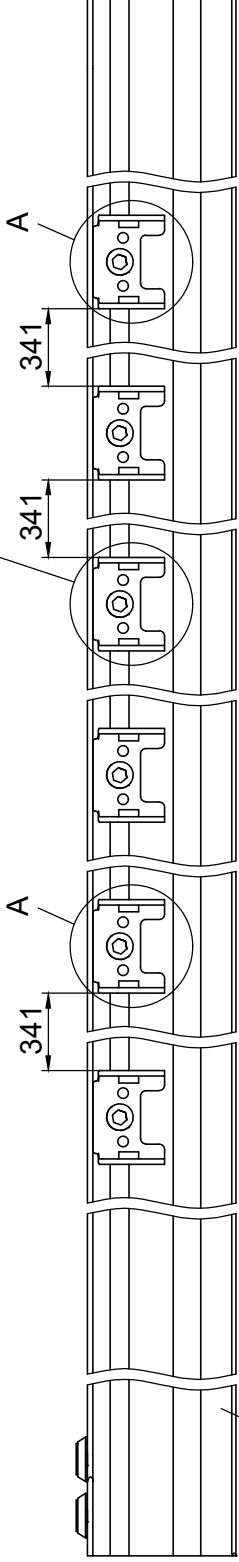
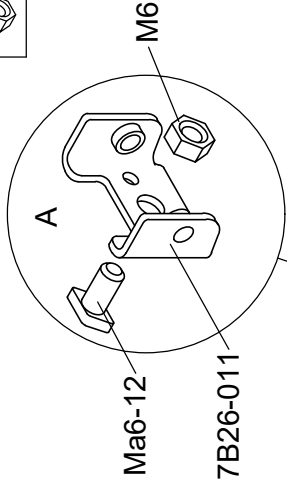

Part	NO.	QTY.	Length(MM)
	40L-S60R	1	3023

Part	NO.	QTY.	Length(MM)	CTN NO.
	Ma6-12	7	PCS	3281P-S-1
	7B26-011	7	PCS	3281P-S-1
	M6	7	PCS	3281P-S-1

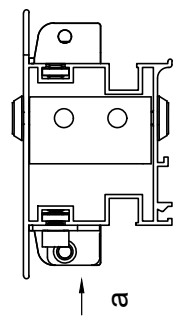
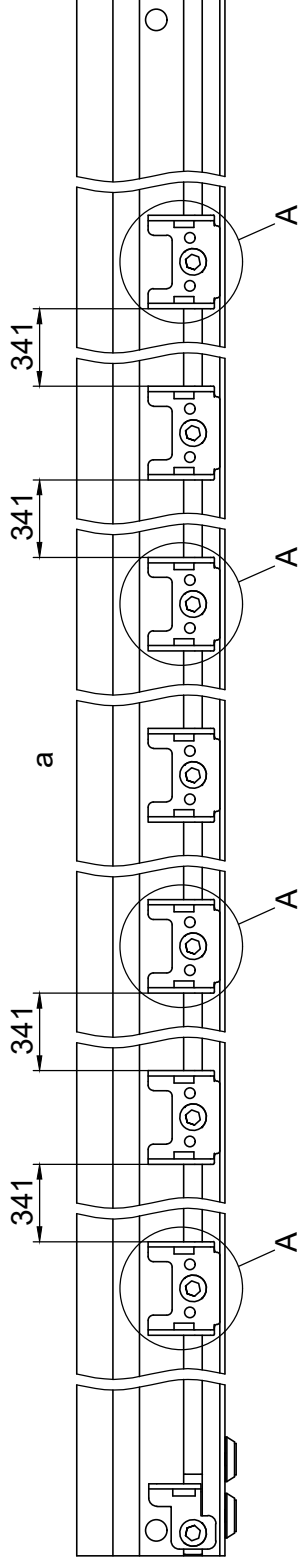

40L-S60R



Part	Product	NO.	Length(MM)	Code
	3281	40L-Y62-4-11	3134	A003
	3283	40L-Y62-6-11	4636	
	3285	40L-Y62-8-11	6138	

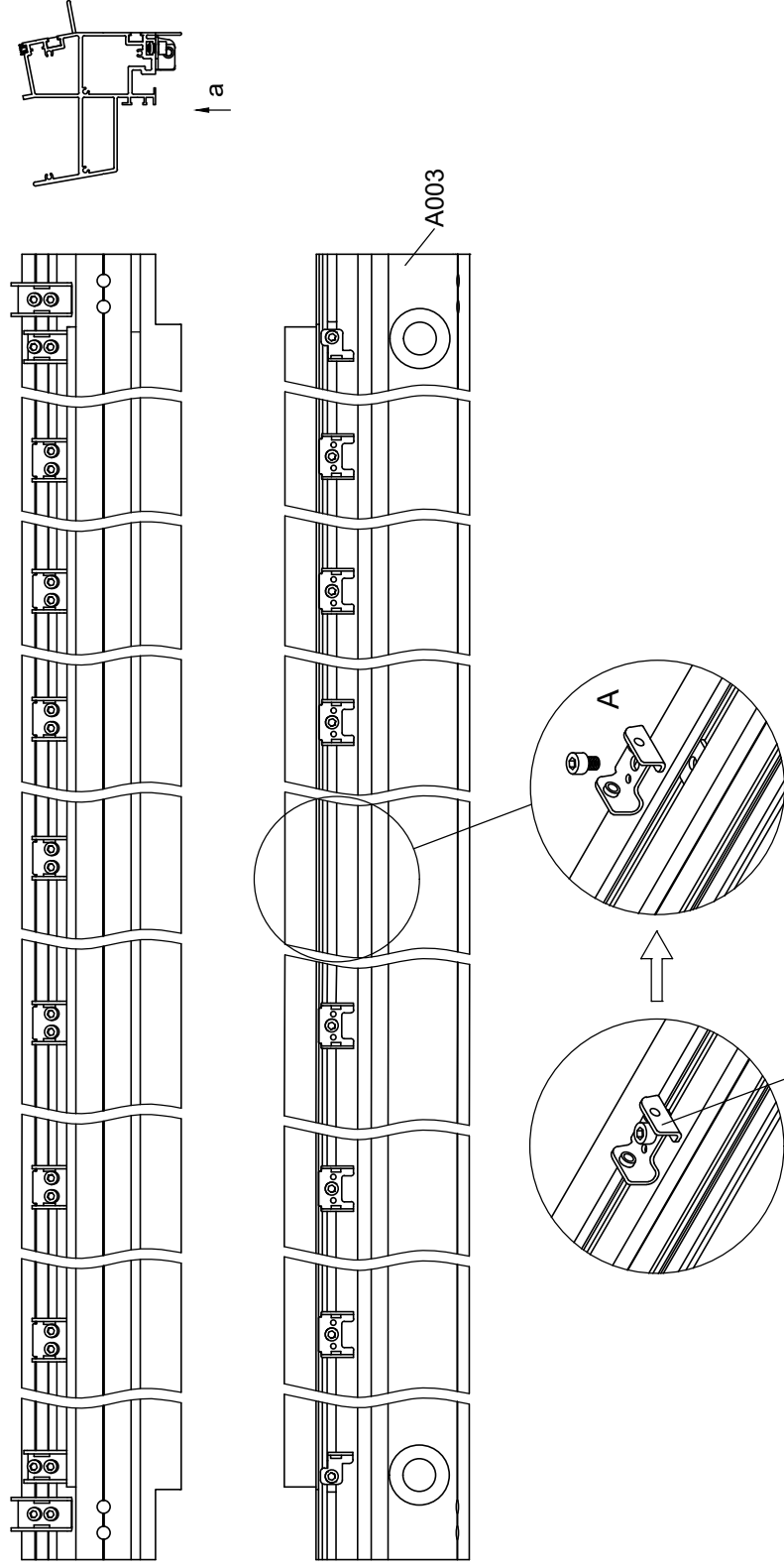





Disassemble this part.

Avmontera fästet från profilen på långsidan.

Afmonter beslaget fra profilen på långsidan.

Demonter festet fra profilen på långsidan.

Irrota profiilin pitkällä sivulla oleva kiinnike.

Part	NO.	QTY.	Length(MM)	Product	Part	NO.	QTY.	Length(MM)	CTN NO.
	40LA-S61L	1	3023	3281/3283/3285		Ma6-12	7	PCS	3281P-S-1
						7B26-011	7	PCS	3281P-S-1
						M6	7	PCS	3281P-S-1

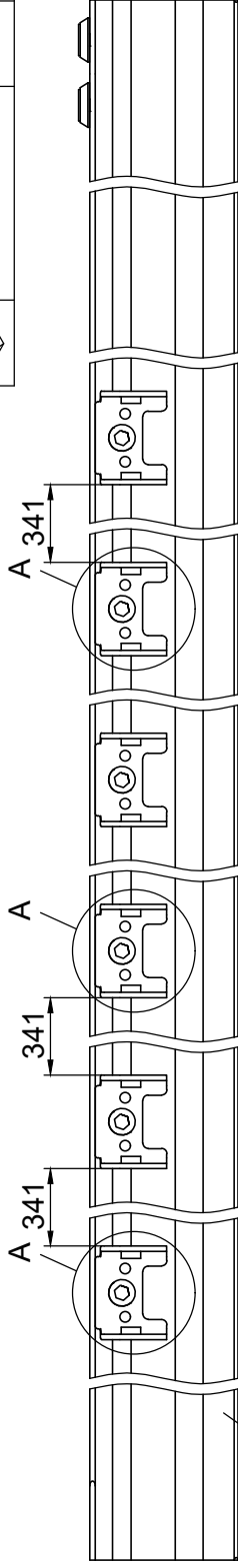



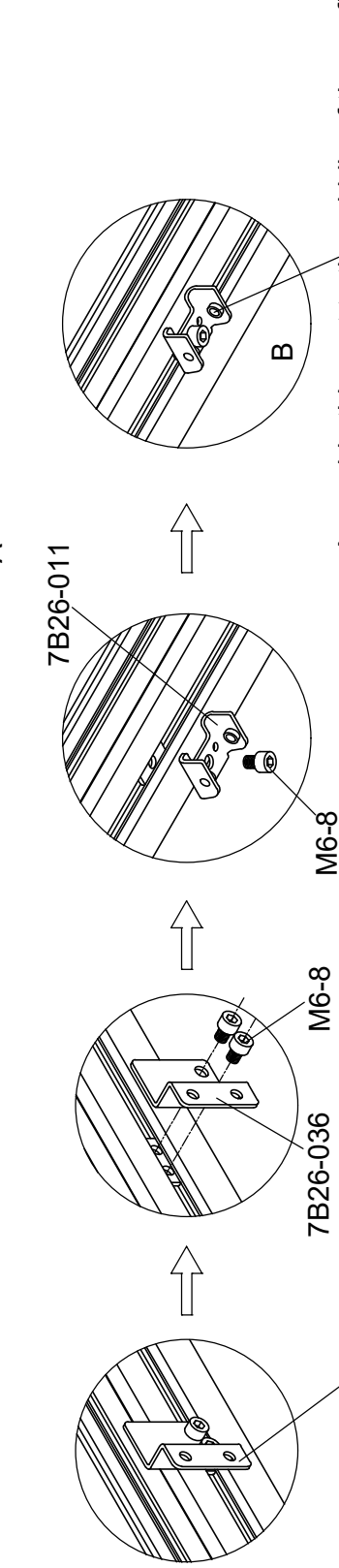
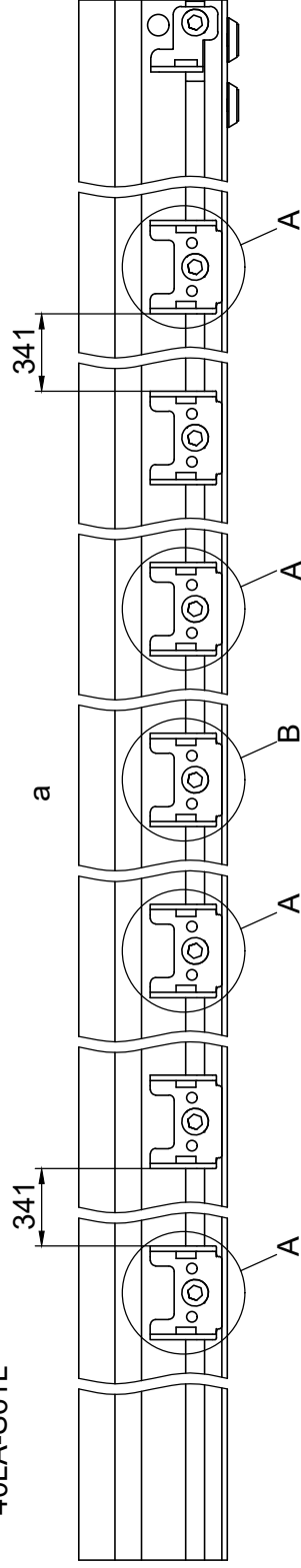

40LA-S61L



Assemble this part to the middle of the profiles.
 Montera fästet i mitten av profilen.
 Montera beslaget i midten af profilen.
 Asenna kiinnike profiilin keskelle.

Disassemble this part.
 Avmontera fästet från profilen på långsidan.
 Afmonter beslaget fra profilen på langsidan.
 Irrota profiilin pitkällä sivulla oleva kiinnike.

Part	NO.	QTY.	Length(MM)	Product	Part	NO.	QTY.	Length(MM)	CTN NO.
	40LA-S61L	1	3023	3282/3284		Ma6-12	8	PCS	3281P-S-1
						7B26-011	8	PCS	3281P-S-1
						M6	8	PCS	3281P-S-1

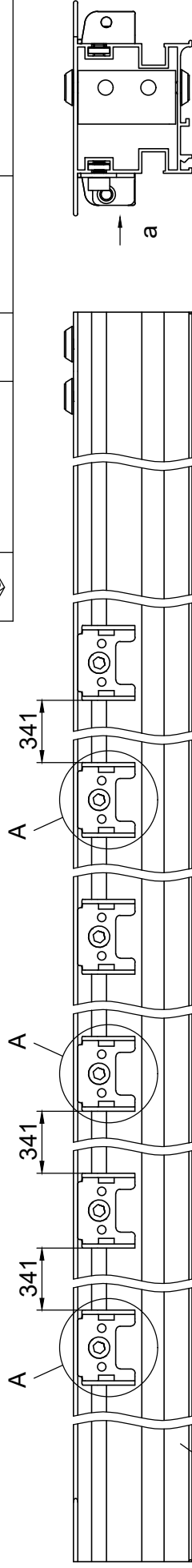

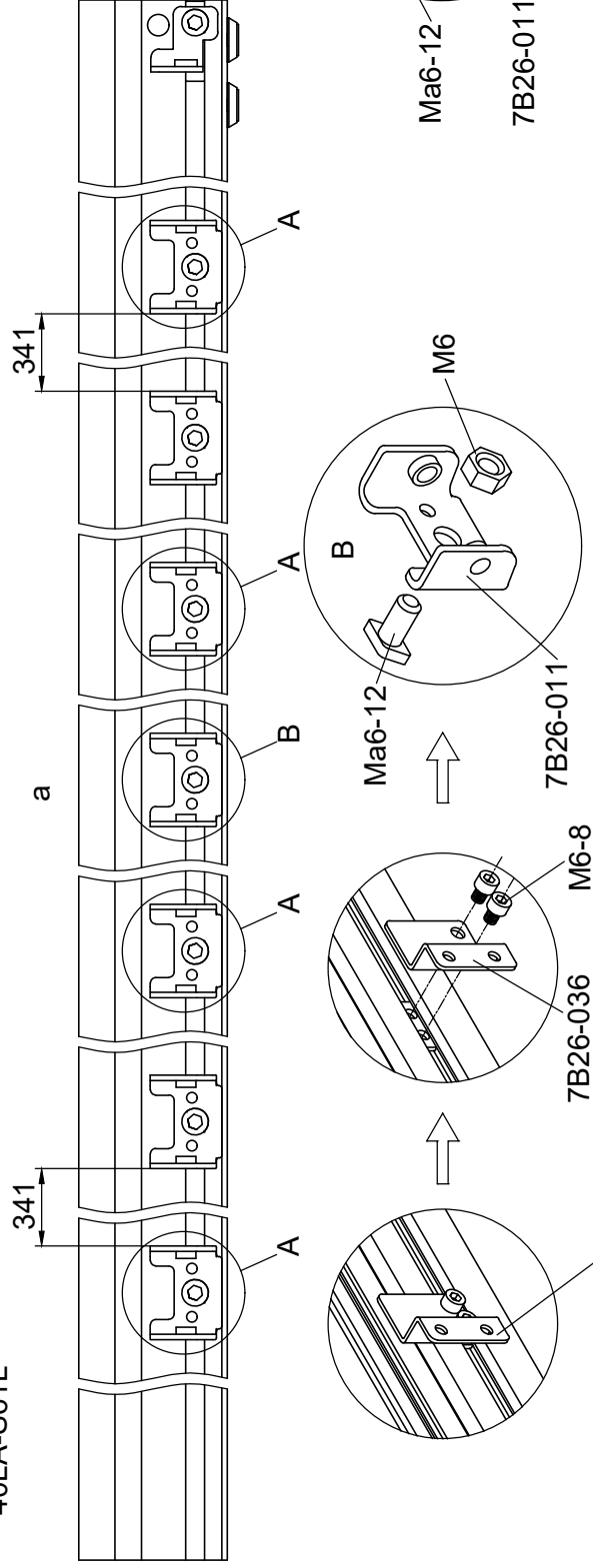

40LA-S61L



Disassemble this part.

- Avmontera fästet från profilen på långsidan.
- Afmonter beslaget fra profilen på langsiden.
- Demontet festet fra profilen på langsiden.
- Irrota profiilin pitkällä sivulla oleva kiinnike.

Part	NO.	QTY.	Length(MM)
	Si6-16	10	PCS
	J05	10	PCS

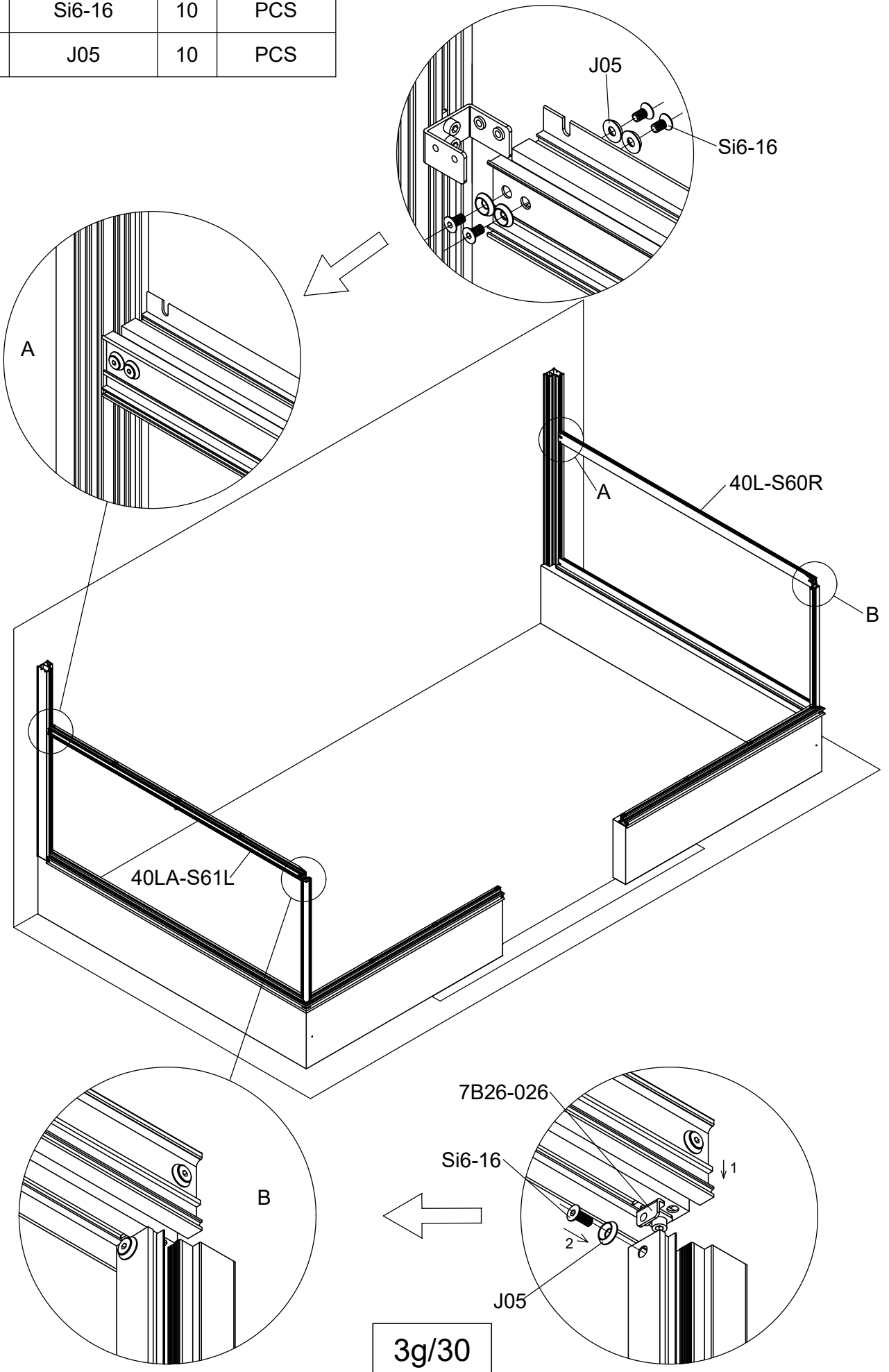

3g/30

Part	Product	NO.	Length(MM)	Code
	3281	40L-Y62-4-11	3134	A003
	3283	40L-Y62-6-11	4636	
	3285	40L-Y62-8-11	6138	

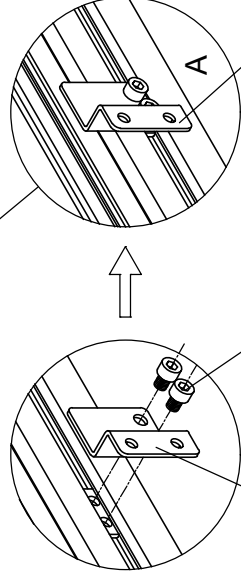
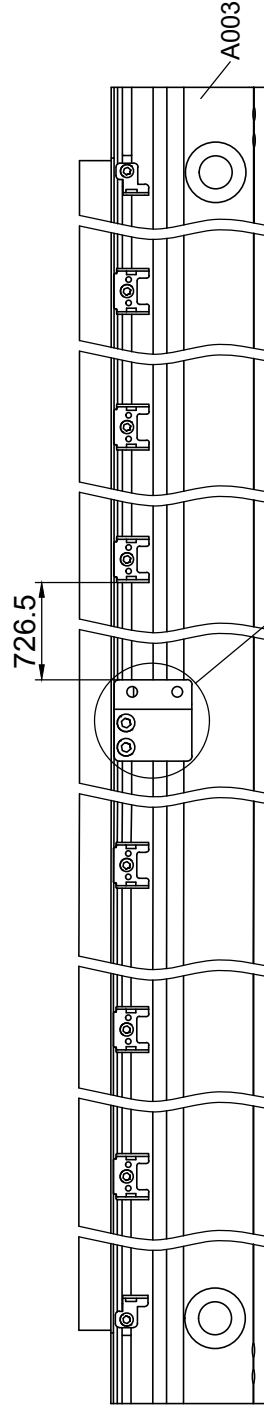
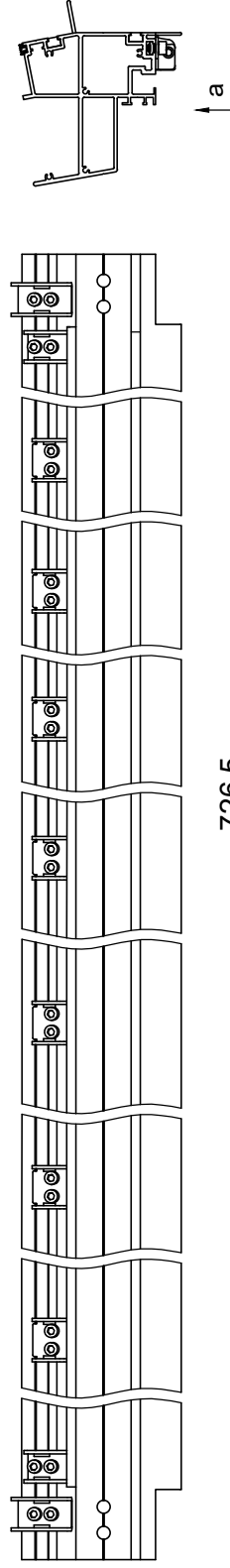

7B26-036

M6-8

Assemble this part to the middle of the profiles.

Montera fästet i mitten av profilen.

Montere beslaget i midten af profilen.

Monter festet i midten av profilen.

Asenna kiinnike profiiliin keskelle.

Part	Product	NO.	Length(MM)	Code
	3282	40L-Y62-5-11	3885	A003
	3284	40L-Y62-7-11	5387	

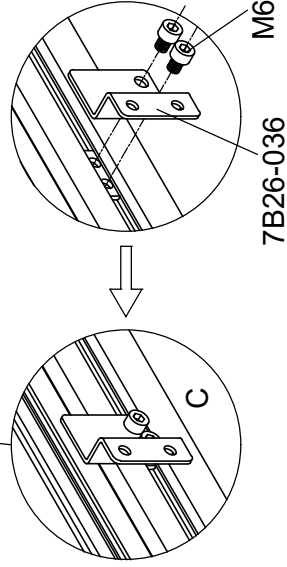
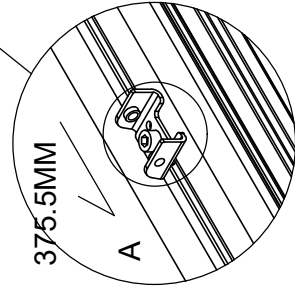
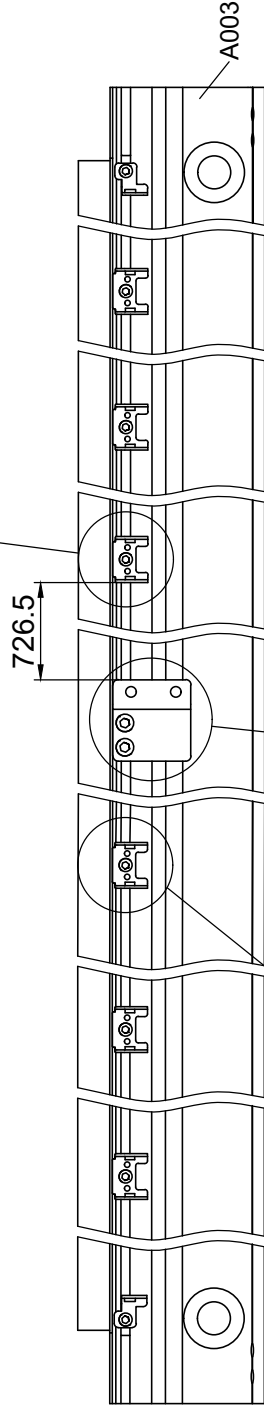
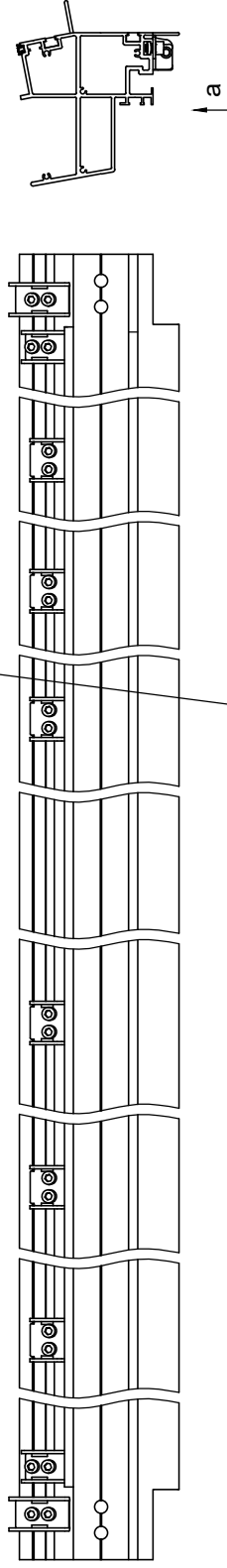
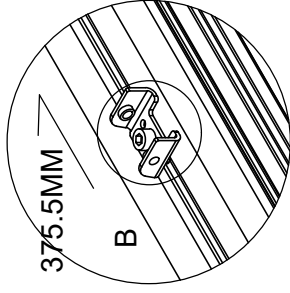



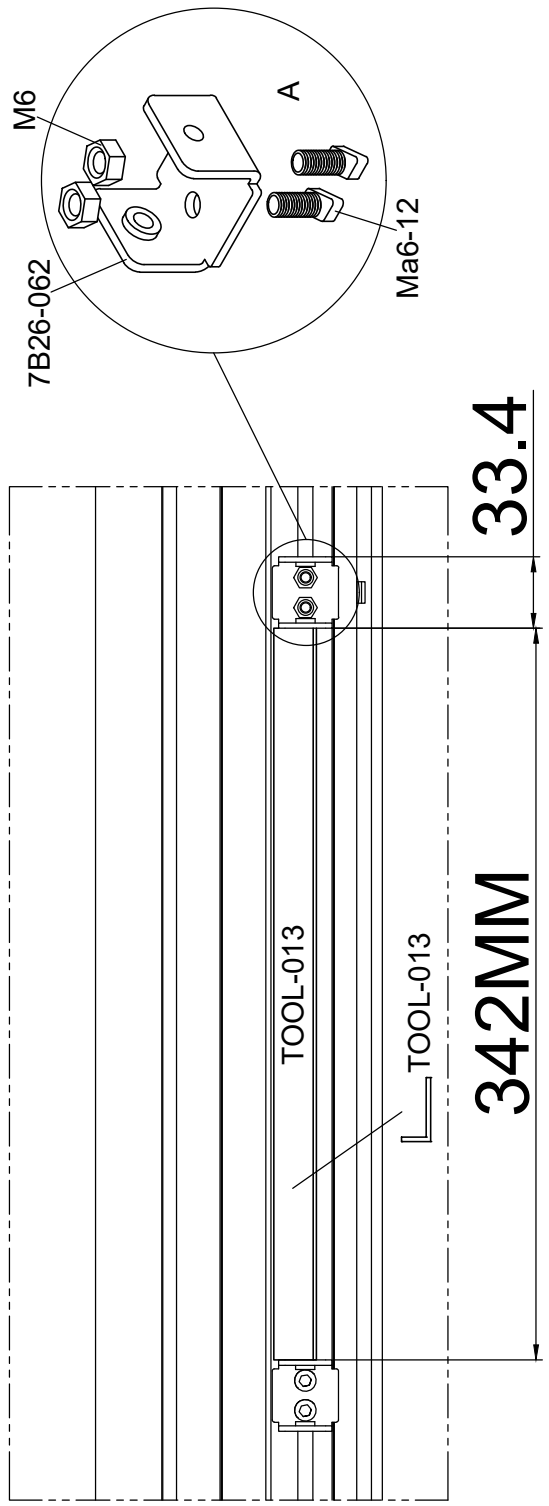
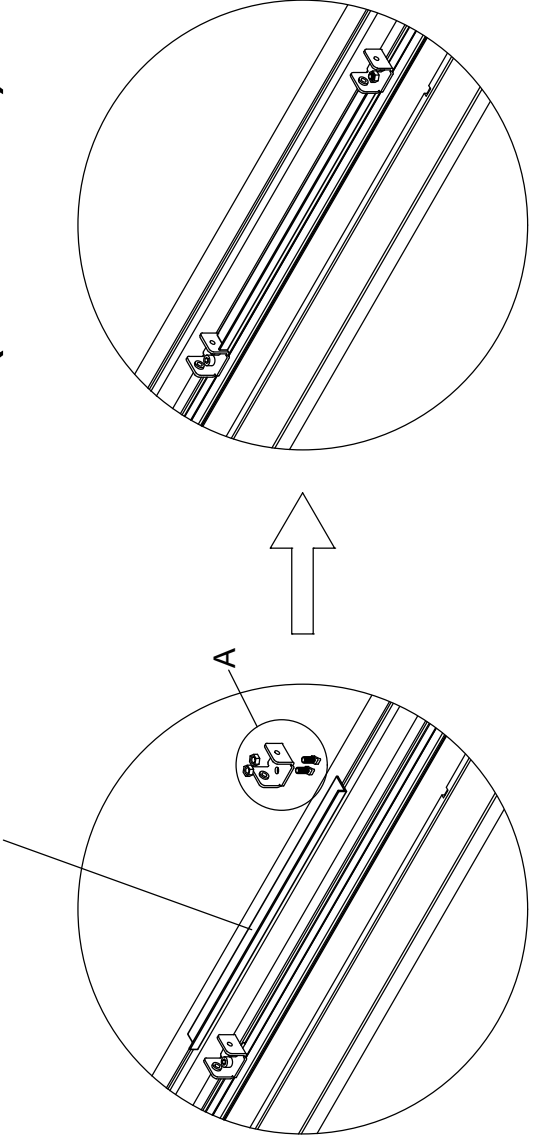

Assemble this part to the middle of the profiles.
 Montera fästet i mitten av profilen.
 Montera beslaget i midten av profilen.
 Monter festet i midten av profilen.
 Asenna kiinnike profiilin keskelle.

L TOOL-013(342MM)

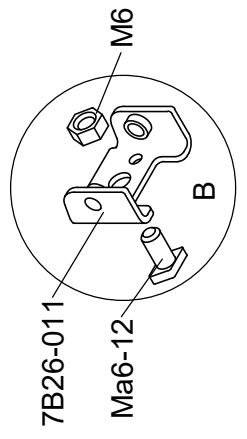
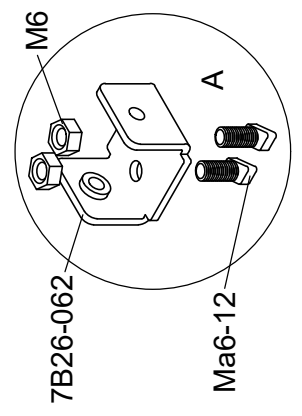
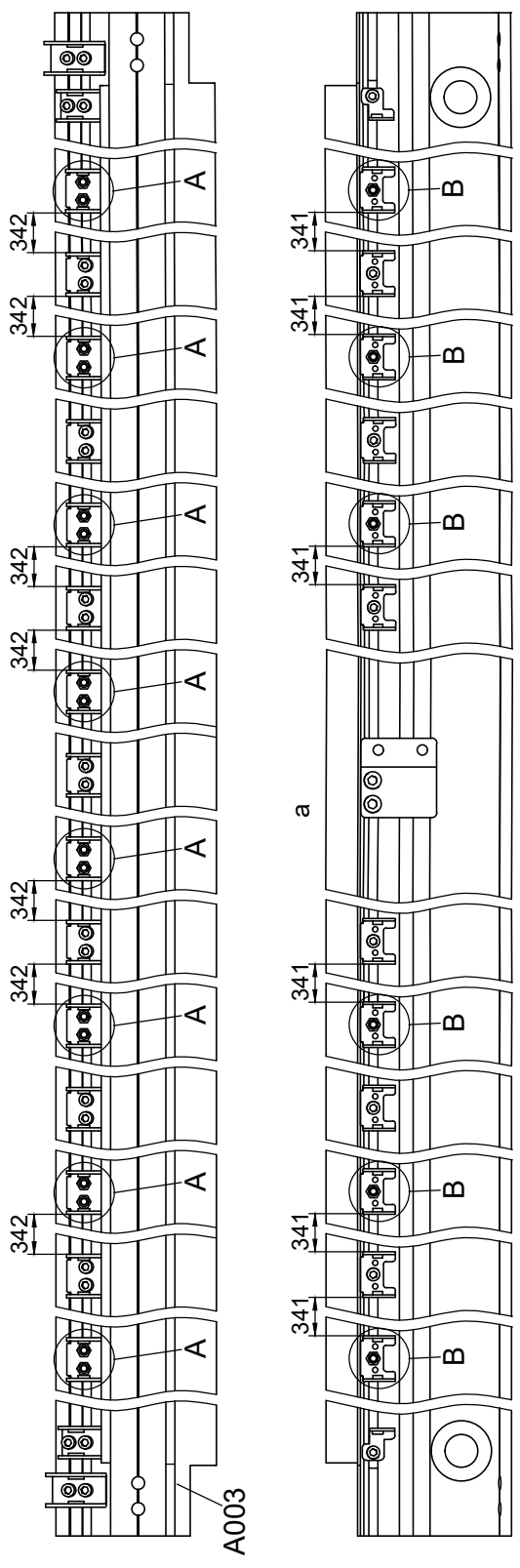
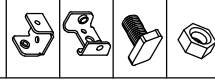



Part	Product	NO.	Length(MM)	QTY.	Code	QTY.												Length (MM)
						3281		3282		3283		3284		3285				
	3281	40L-Y62-4	3134			3281P -S-1	3281P -S-2	3281P -S-1	3281P -S-2	3281P -S-1	3281P -S-2	3281P -S-1	3281P -S-2	3281P -S-1	3281P -S-2	3285		
	3282	40L-Y62-5	3885			4	0	4	1	4	2	4	3	4	4	PCS		
	3283	40L-Y62-6	4636	1	A003	2	0	1	1	2	2	1	3	2	4	PCS		
	3284	40L-Y62-7	5387			10	0	9	3	10	6	9	10	12	PCS			
	3285	40L-Y62-8	6138			10	0	9	3	10	6	9	10	12	PCS			

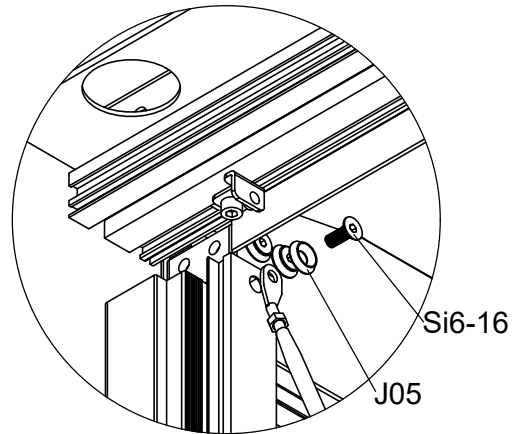
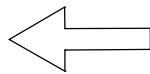
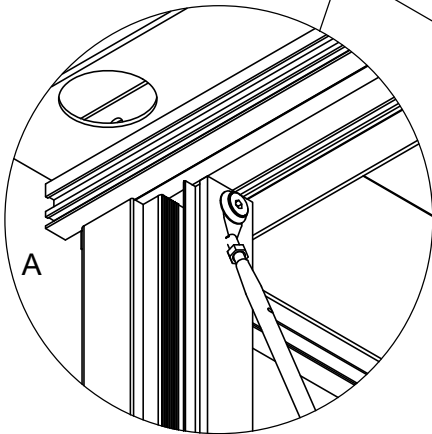
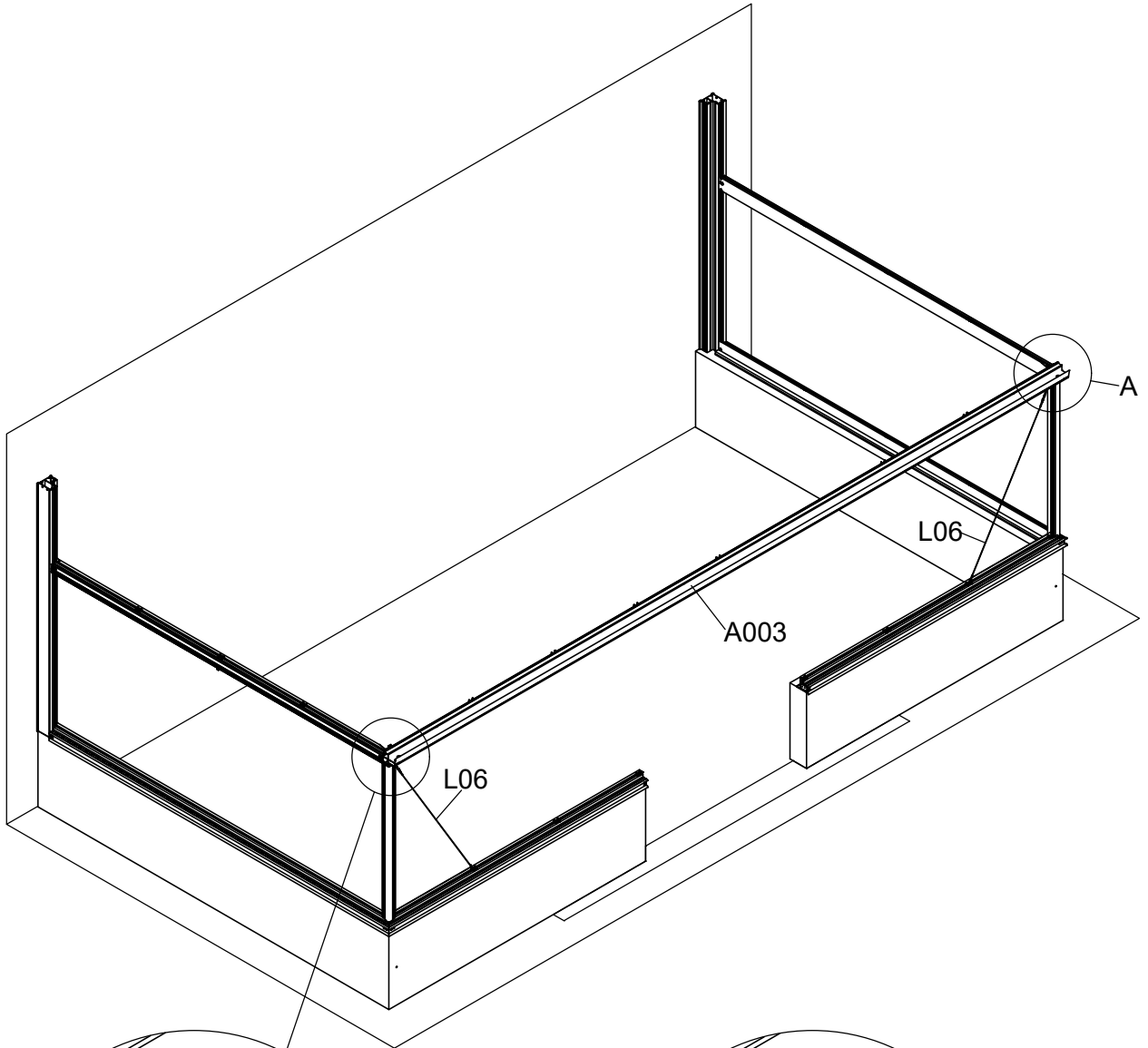

Part	NO.	QTY.	Length(MM)
	Si6-16	2	PCS
	J05	2	PCS
	L06	2	1400



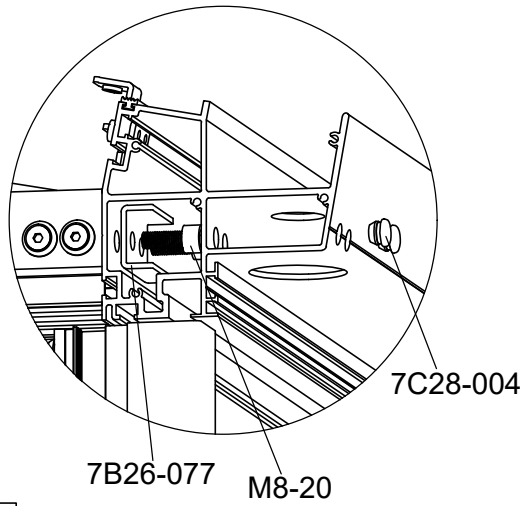
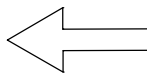
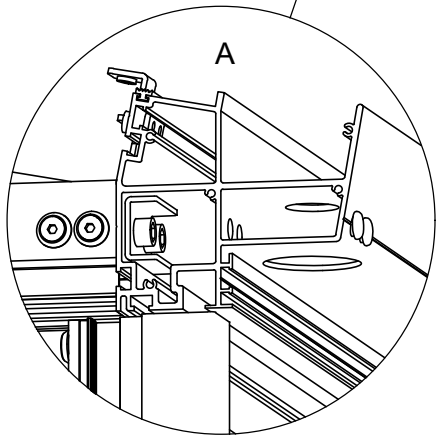
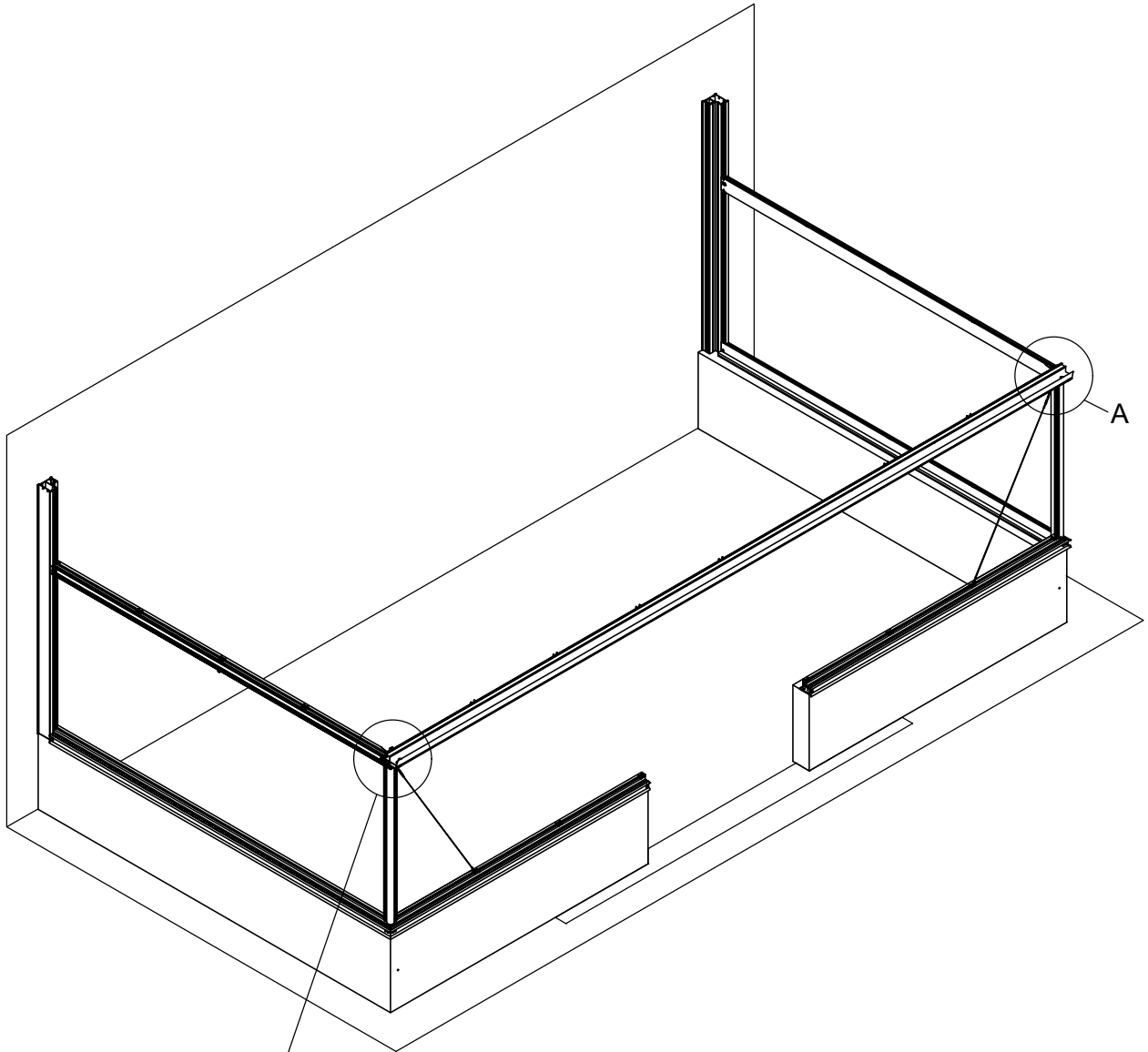

Part	NO.	QTY.	Length(MM)
	7B26-077	2	PCS
	M8-20	4	PCS
	7C28-004	4	PCS

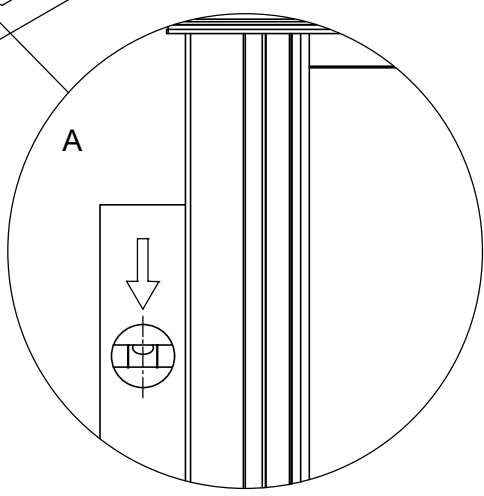
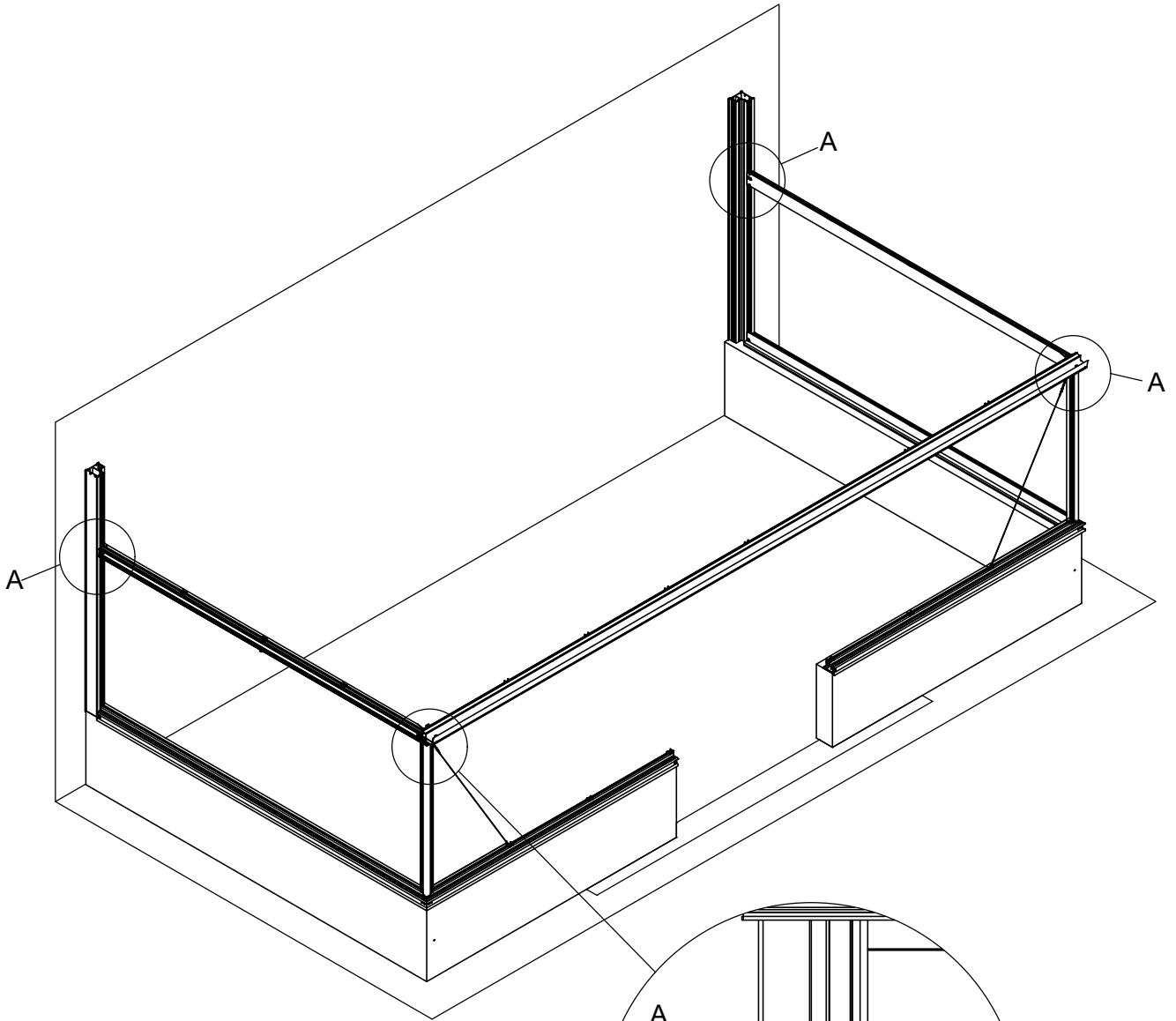





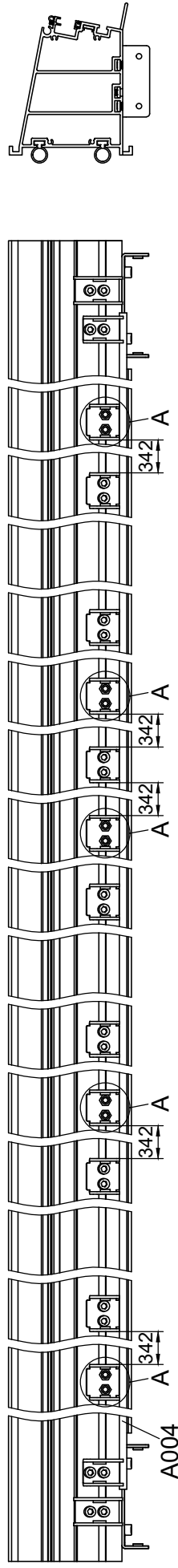

4g/30

Part	Product	NO.	Length (MM)	QTY.	Code	QTY.										Length (MM)
						3281		3282		3283		3284		3285		
Part	NO.	3281P -S-1	3281P -S-2	3281P -S-1	3281P -S-2	3281P -S-1	3281P -S-2	3281P -S-1	3281P -S-2	3281P -S-1	3281P -S-2	3281P -S-1	3281P -S-2	3281P -S-1	3281P -S-2	
		7B26-062	3	0	3	0	3	0	3	1	3	3	1	3	2	
		Ma6-12	6	0	6	0	6	0	6	2	6	2	6	4		
		M6	6	0	6	0	6	0	6	2	6	2	6	4		



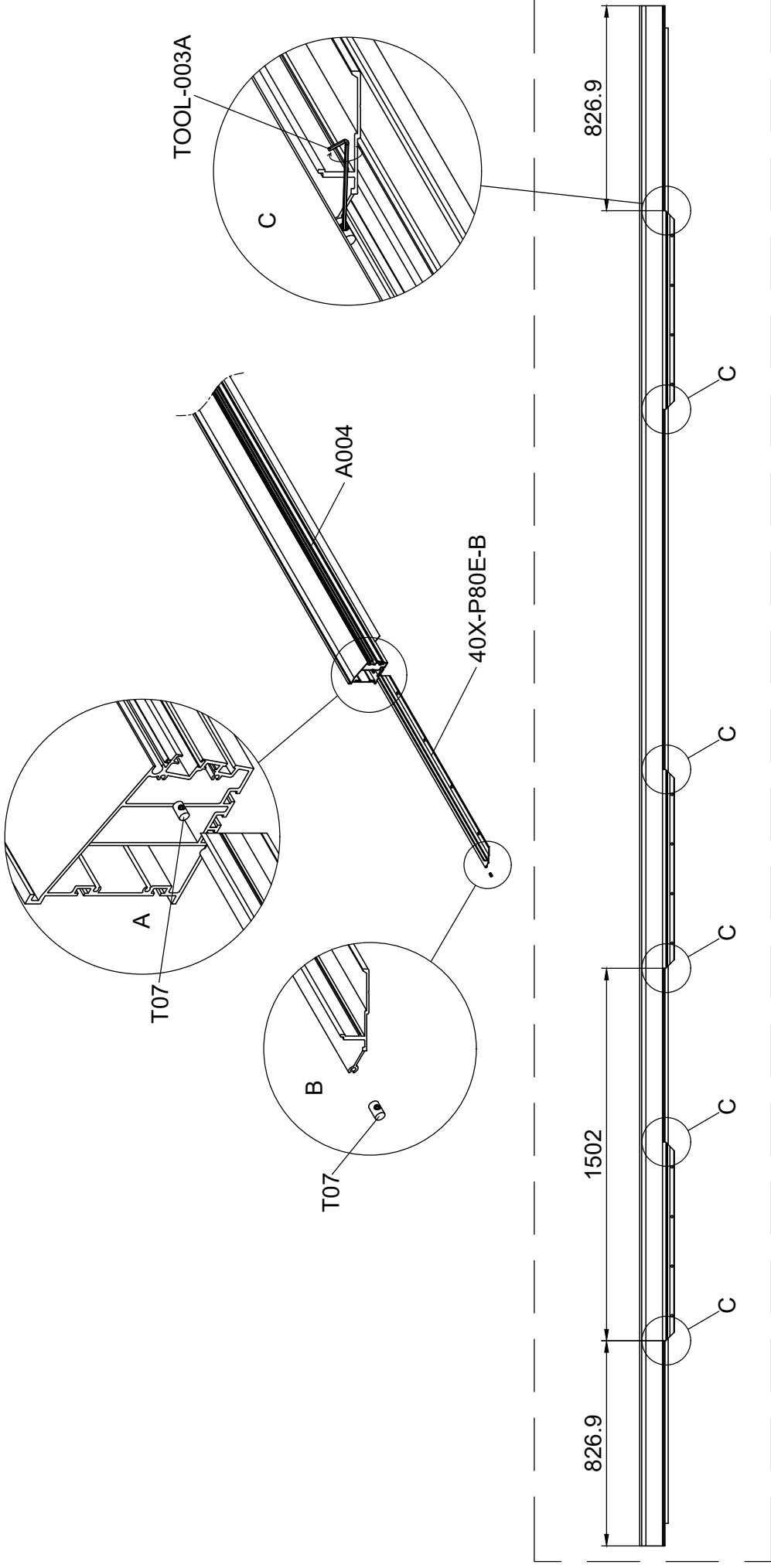

Part	NO.	QTY.						Length(MM)
		3281	3282	3283	3284	3285		
	40X-P80E-B	1	2	2	3	3	801	
	T07	2	4	4	6	6	PCS	



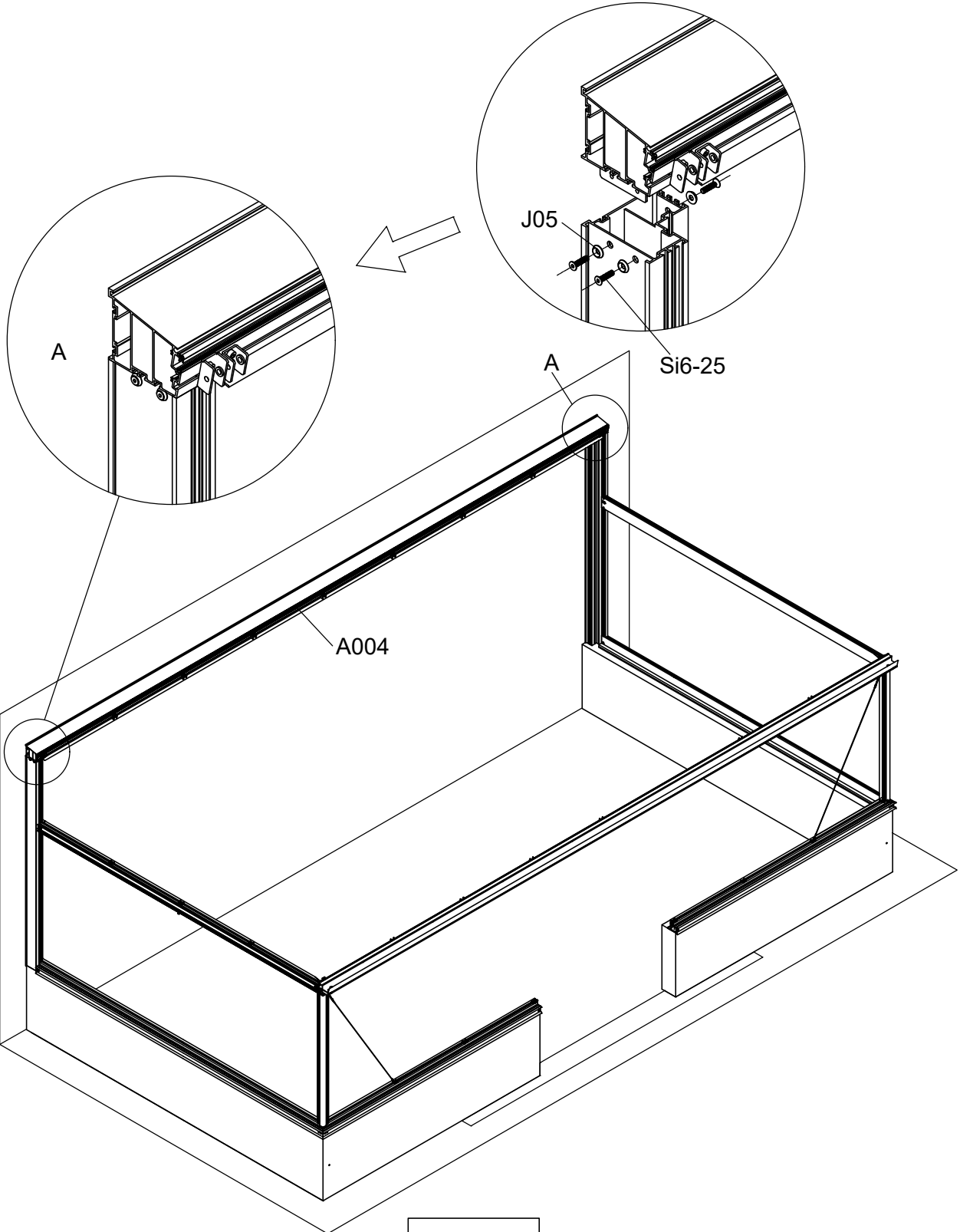



Part	NO.	QTY.	Length(MM)
	Si6-25	6	PCS
	J05	6	PCS

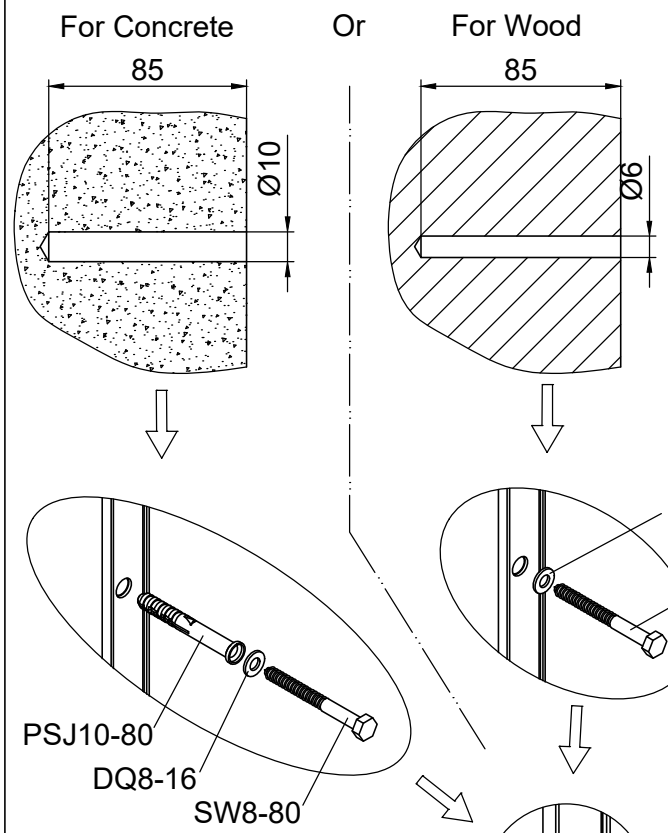

Part	NO.	QTY.					Length(MM)	
		3181	3182	3183	3184	3185		
	PSJ10-80	18	20	20	22	22	PCS	For Concrete
	DQ8-16	18	20	20	22	22	PCS	For Concrete/For Wood
	SW8-80	18	20	20	22	22	PCS	For Concrete/For Wood





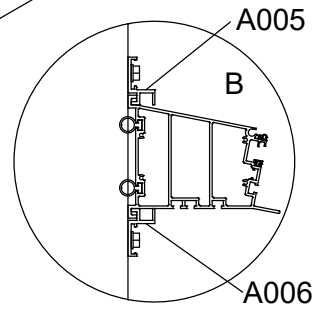
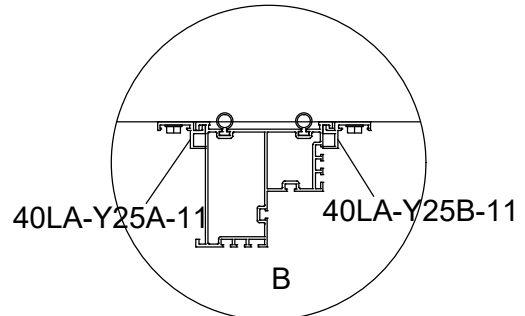
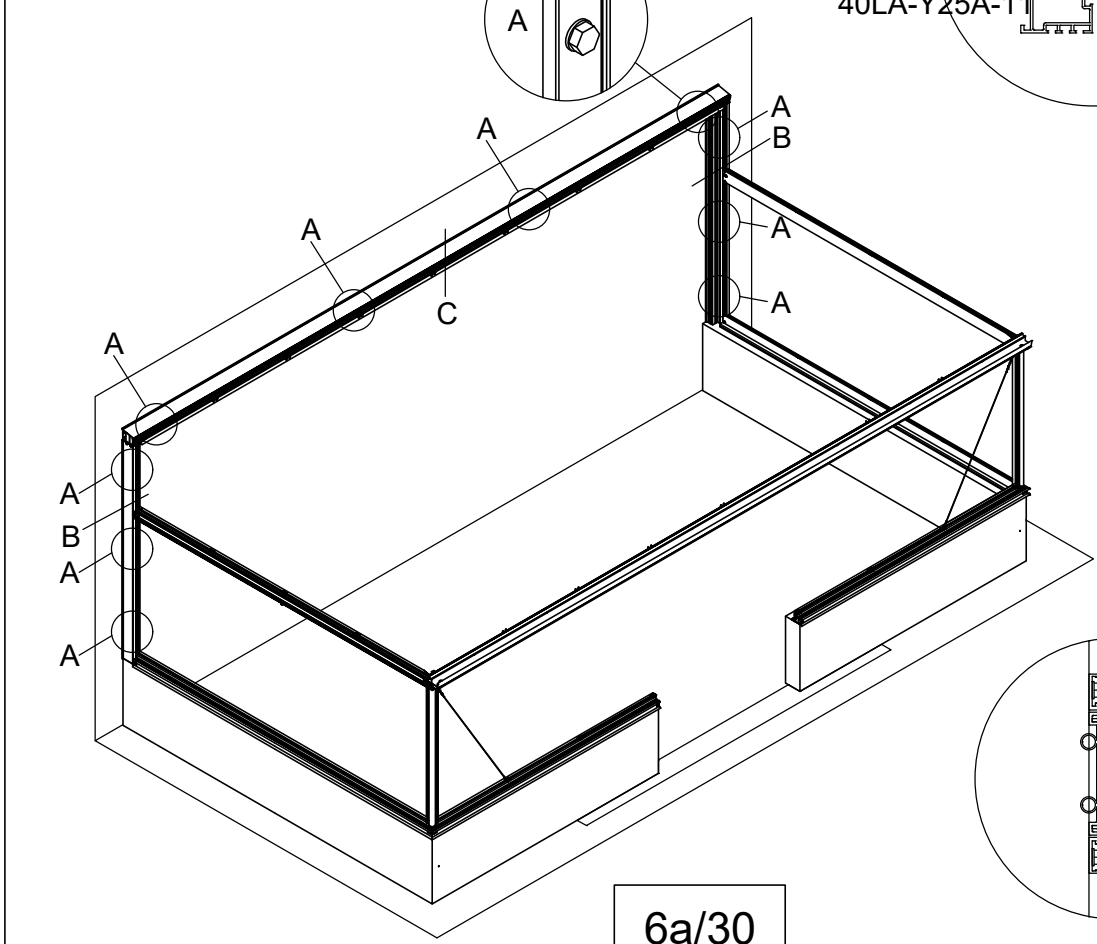

Part	Product	NO.	Length(MM)	QTY.	Code
	3181	40LA-Y26A-4	3157	1	A005
	3182	40LA-Y26A-5	3908		
	3183	40LA-Y26A-6	4659		
	3184	40LA-Y26A-7	5410		
	3185	40LA-Y26A-8	6161		
	3181	40LA-Y26B-4	2899	1	A006
	3182	40LA-Y26B-5	3650		
	3183	40LA-Y26B-6	4401		
	3184	40LA-Y26B-7	5152		
	3185	40LA-Y26B-8	5903		

Part	NO.	QTY.	Length(MM)
	40LA-Y25A-11	2	1960
	40LA-Y25B-11	2	1911



6a/30

Part	NO.	QTY.	Length(MM)
	40LA-Y27A-11	2	1960
	40LA-Y27B-11	2	1911



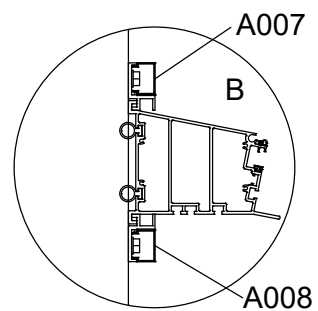
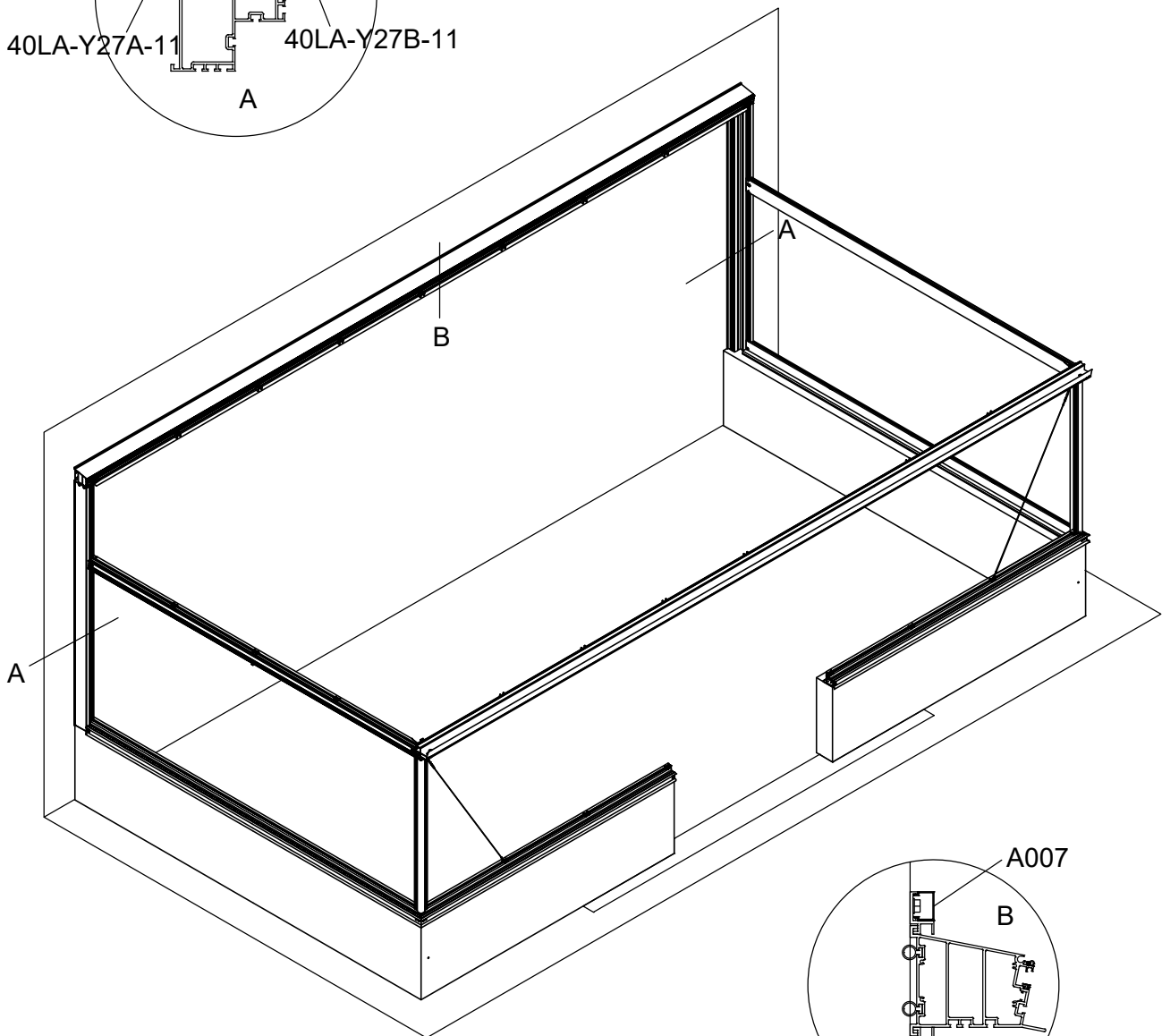
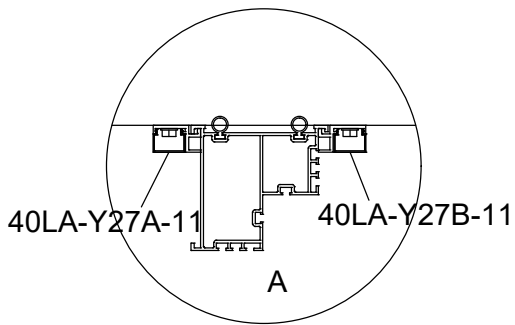

Part	Product	NO.	Length(MM)	QTY.	Code
	3181	40LA-Y28A-4	3157	1	A007
	3182	40LA-Y28A-5	3908		
	3183	40LA-Y28A-6	4659		
	3184	40LA-Y28A-7	5410		
	3185	40LA-Y28A-8	6161		
	3181	40LA-Y28B-4	2917	1	A008
	3182	40LA-Y28B-5	3668		
	3183	40LA-Y28B-6	4419		
	3184	40LA-Y28B-7	5170		
	3185	40LA-Y28B-8	5921		

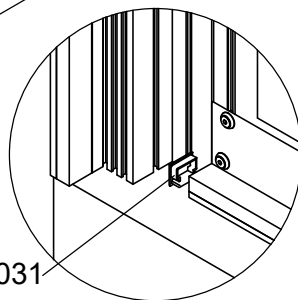
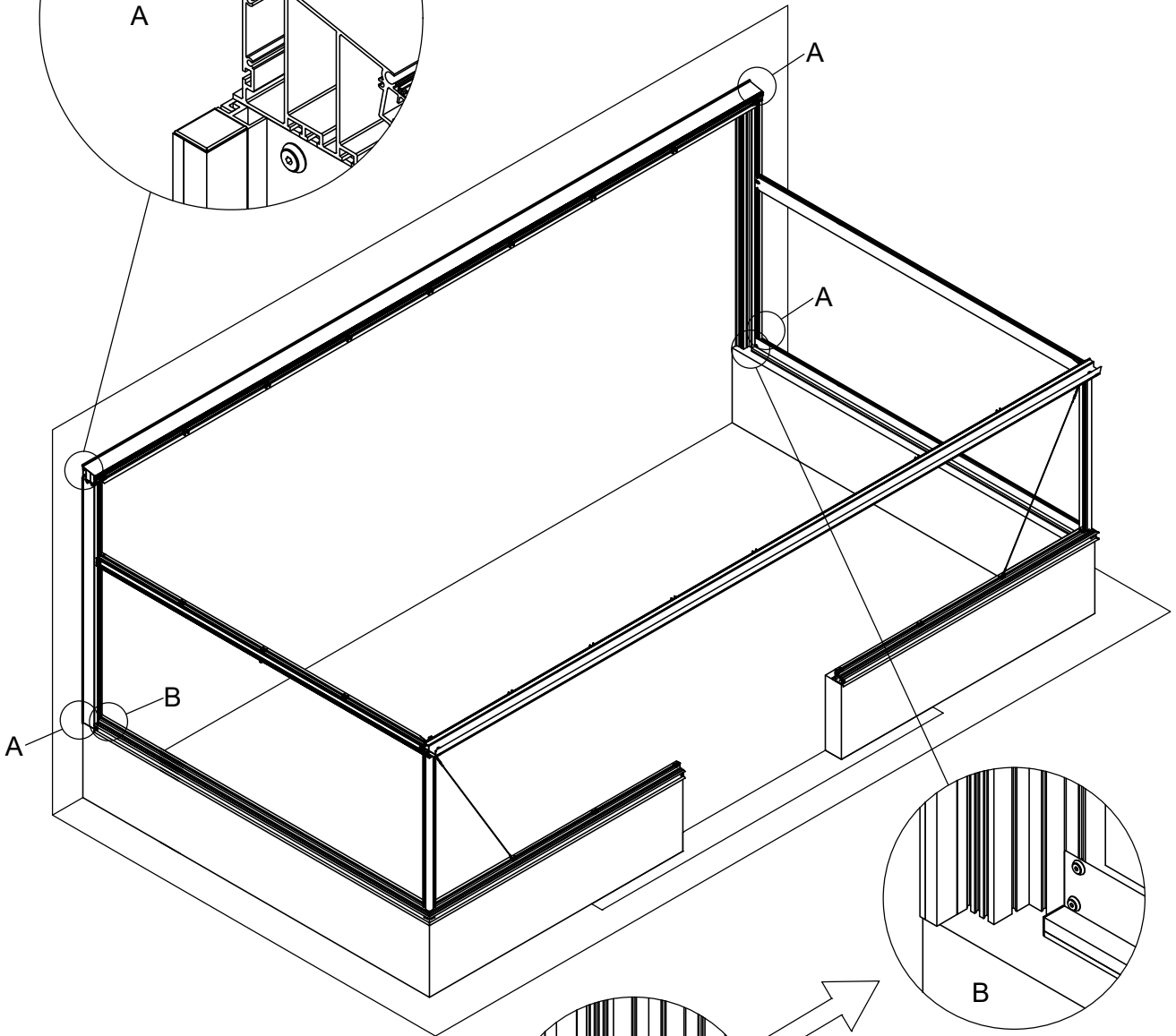
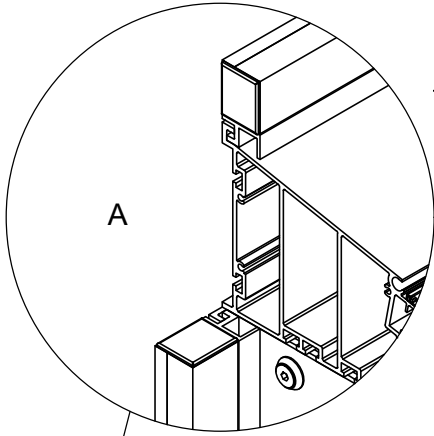
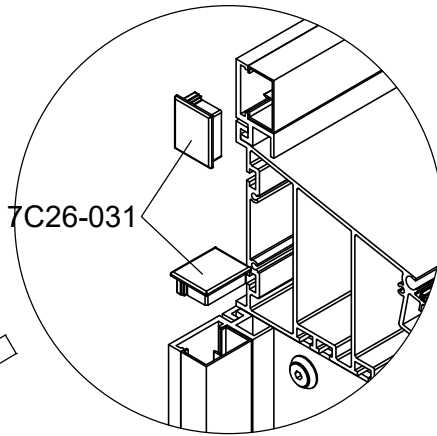

Part	NO.	QTY.	Length(MM)
	7C26-031	8	PCS



6c/30

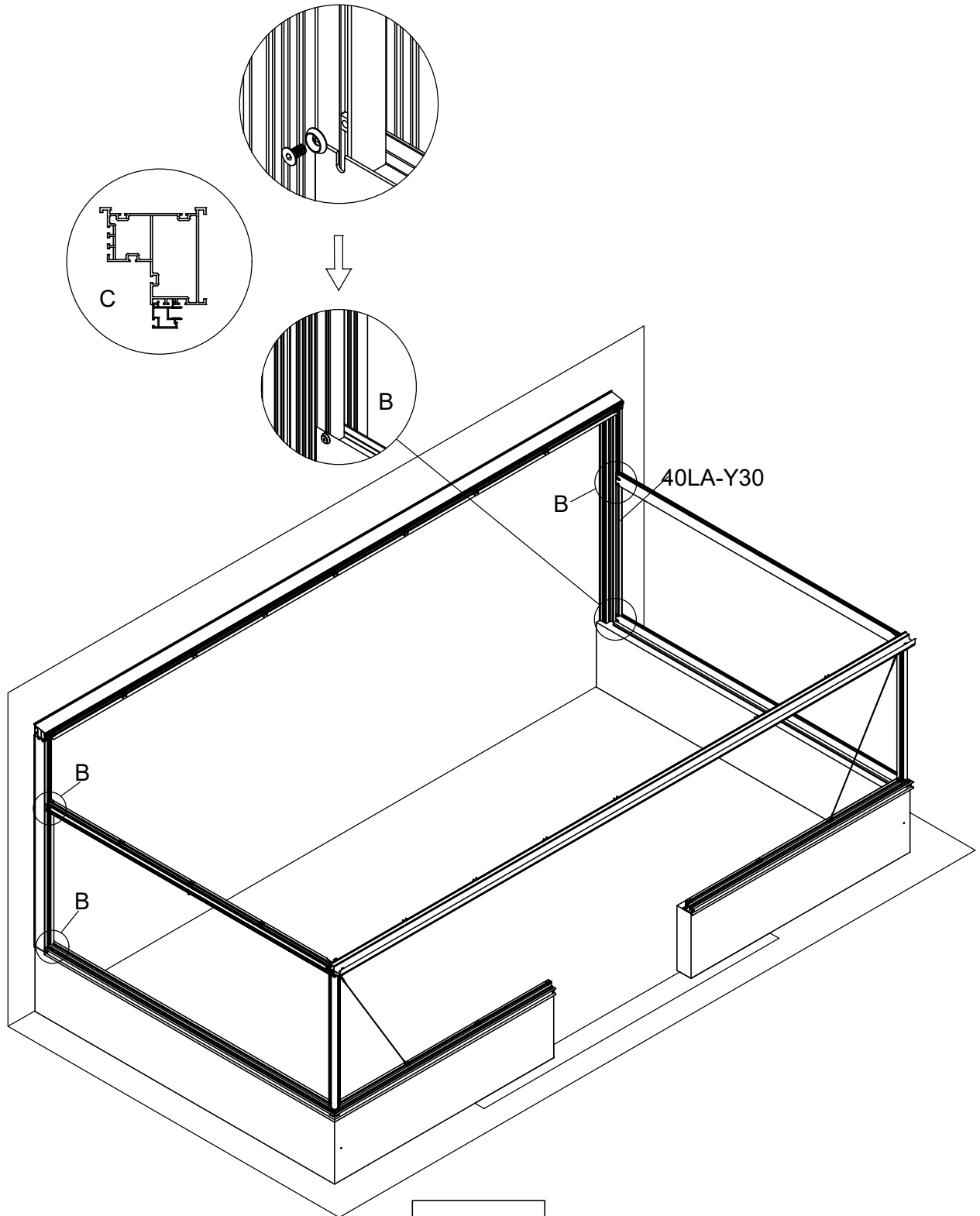

Part	NO.	QTY.	Length(MM)
	40LA-Y30	2	1235
	Si6-12	4	PCS
	J05	4	PCS
	MF6	4	PCS

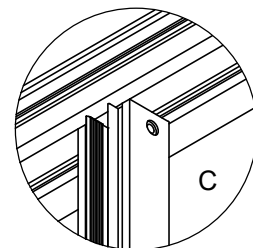
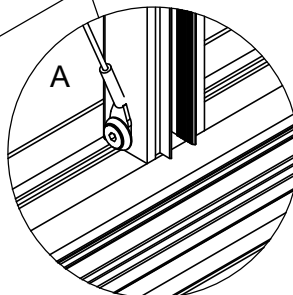
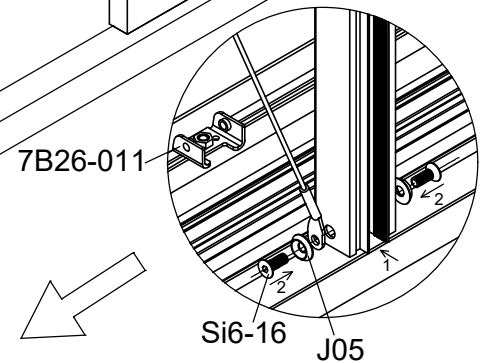
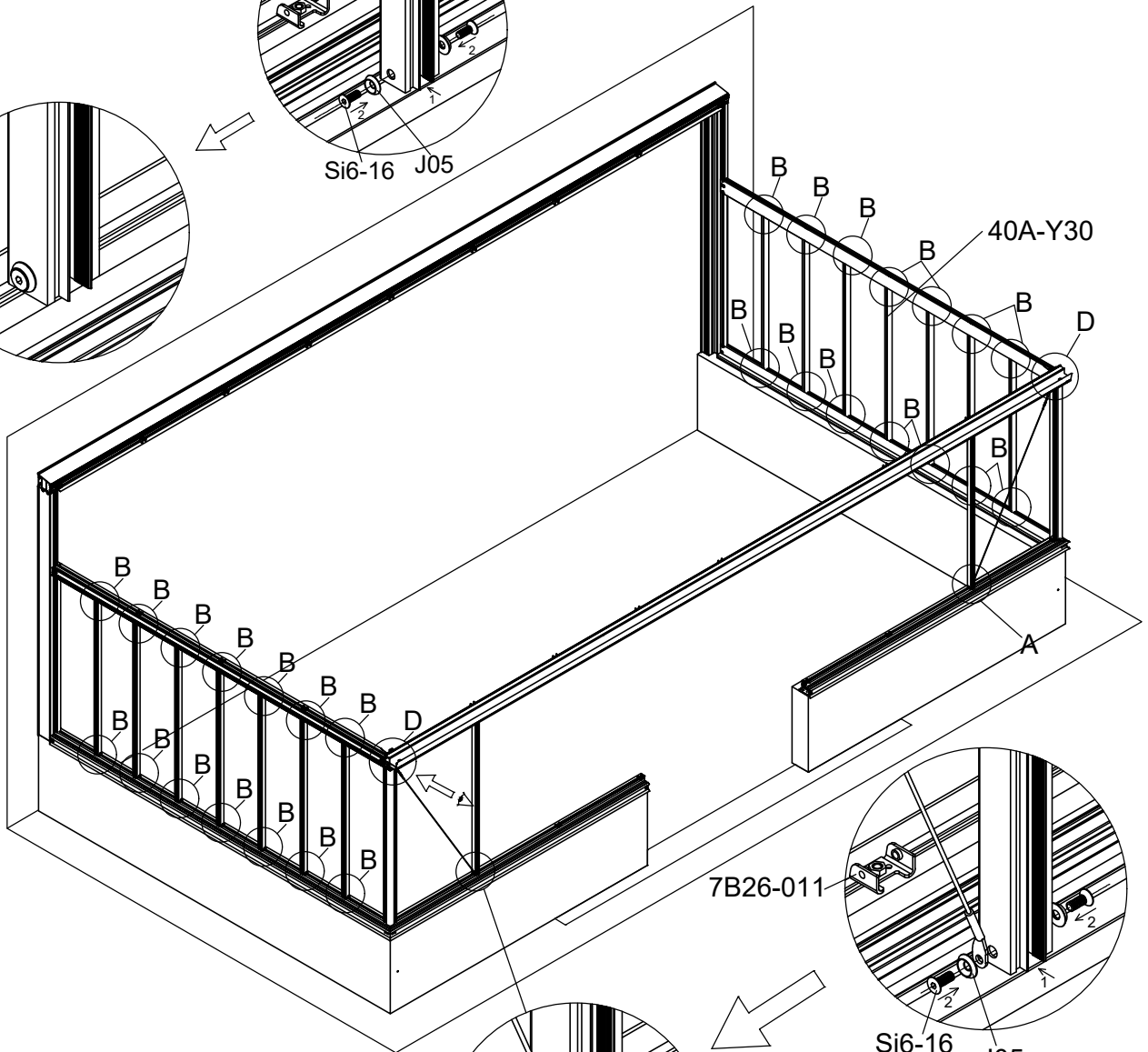
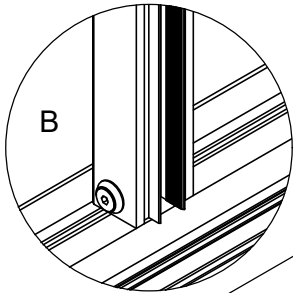
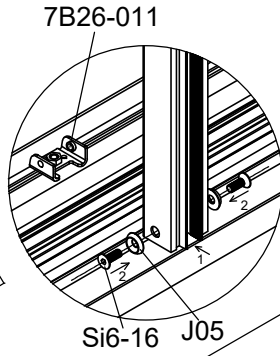
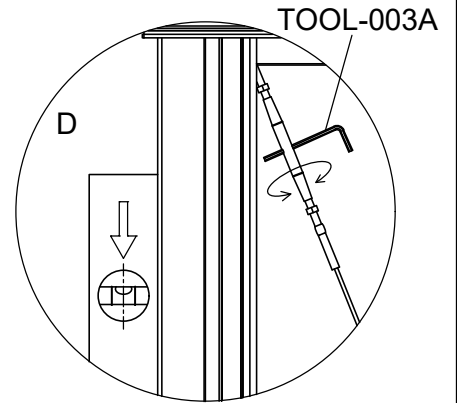

Part	NO.	QTY.										Length (MM)
		3281		3282		3283		3284		3285		
		3281	3281P -S-1	3282	3282P -S-1	3283	3283P -S-1	3284	3284P -S-1	3285	3285P -S-1	
	40A-Y30	8	8	7	9	8	8	7	9	8	8	1235
	Si6-16	26	32	24	36	26	32	24	36	26	32	PCS
	J05	26	32	24	36	26	32	24	36	26	32	PCS





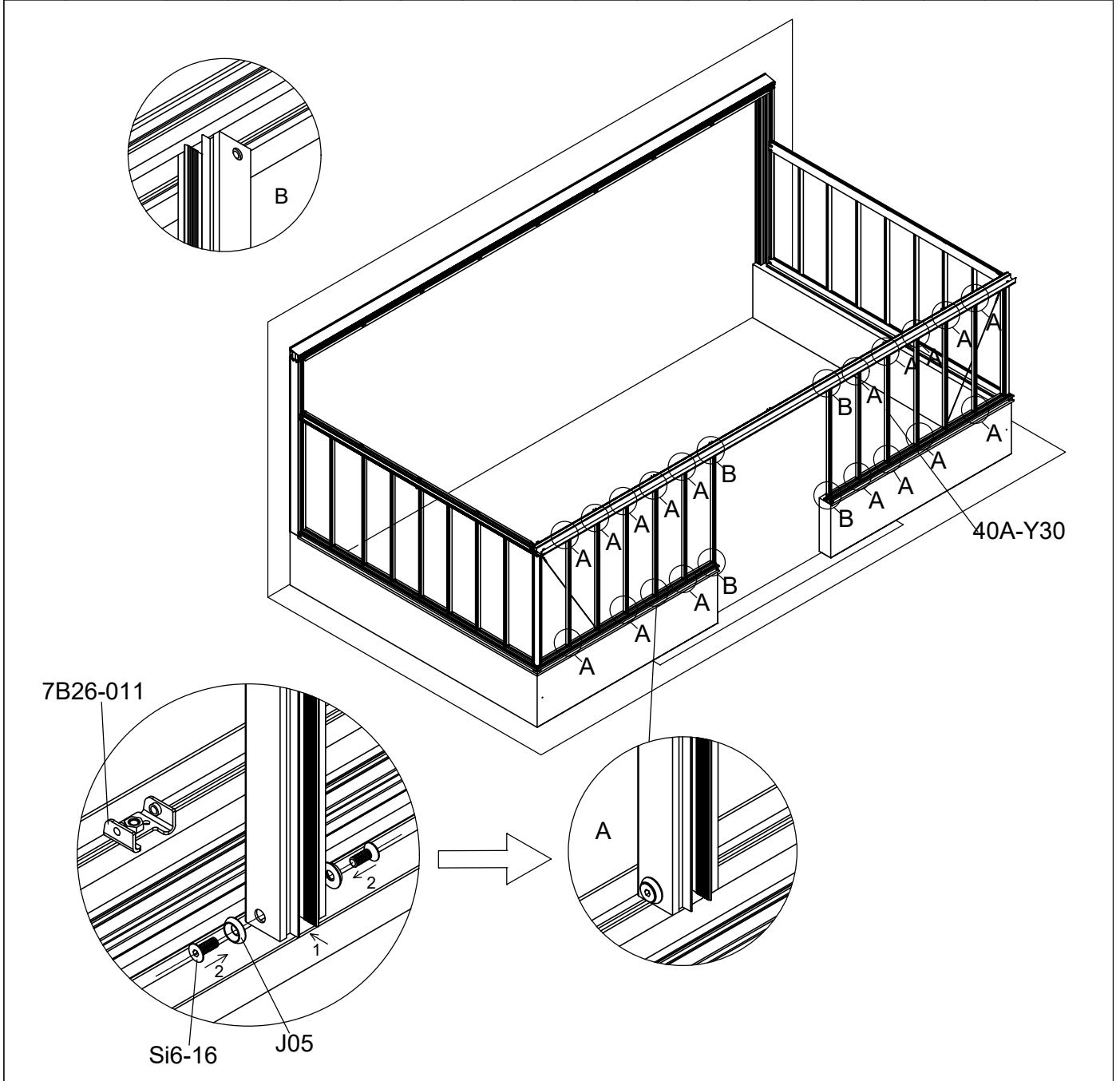

7b/30

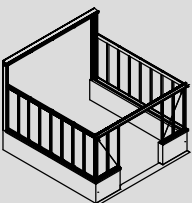
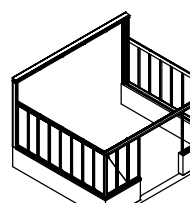
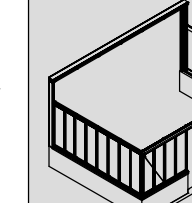
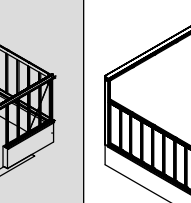
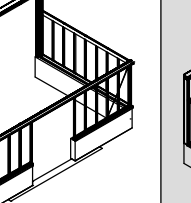





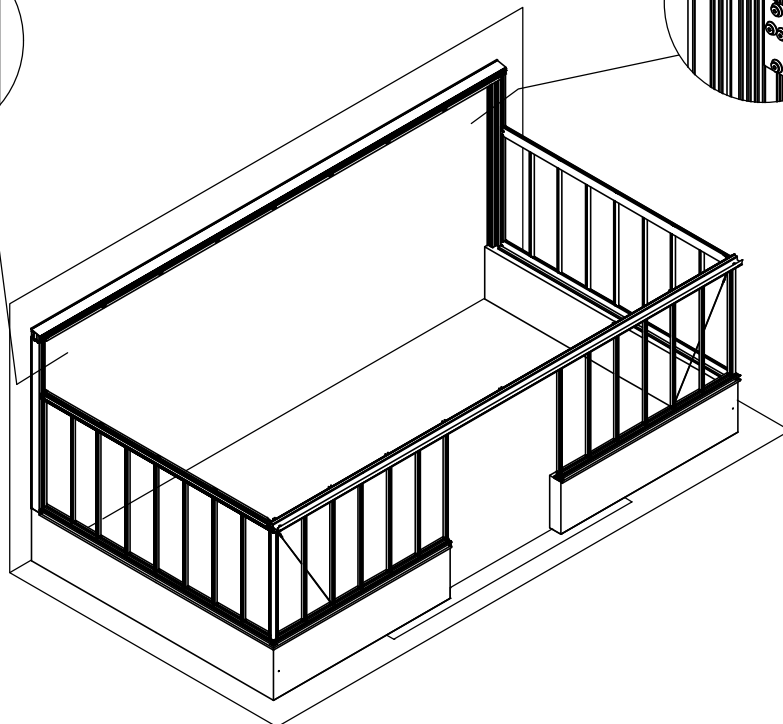
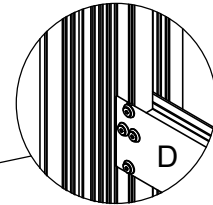
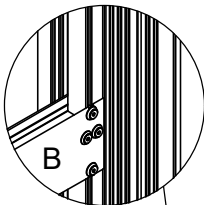
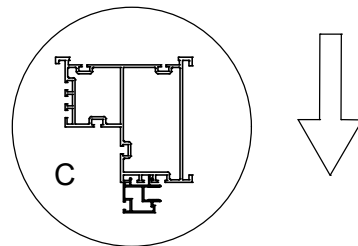
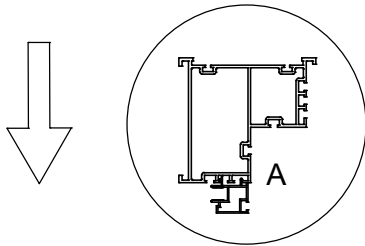
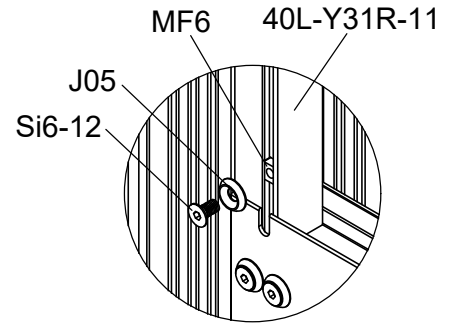
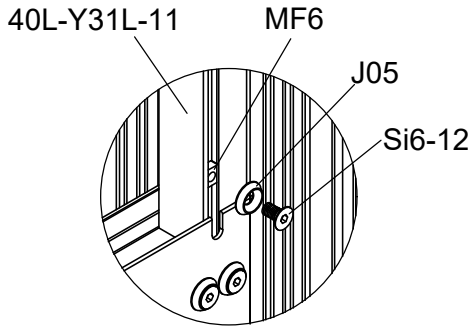

Part	NO.	QTY.															Length (MM)
		3281			3282			3283			3284			3285			
		3281	3281P-S-1	3281P-S-2	3282	3281P-S-1	3281P-S-2	3283	3281P-S-1	3281P-S-2	3284	3281P-S-1	3281P-S-2	3285	3281P-S-1	3281P-S-2	
	40A-Y30	0	2	0	2	1	1	2	2	2	4	1	3	4	2	4	1235
	Si6-16	2	8	0	8	4	4	8	8	8	16	4	12	16	8	16	PCS
	J05	2	8	0	8	4	4	8	8	8	16	4	12	16	8	16	PCS











3281	3282	3283	3284	3285
				

Part	NO.	QTY.	Length(MM)
	40L-Y31R-11	1	561
	40L-Y31L-11	1	561
	Si6-12	2	PCS
	J05	2	PCS
	MF6	2	PCS



Part	NO.	QTY.	Length(MM)
	40X-Y31R-11A	1	124
	40X-Y31L-11A	1	124
	40X-Y31R-11B	1	270
	40X-Y31L-11B	1	270
	40X-Y31R-11C	1	416
	40X-Y31L-11C	1	416
	Si6-16	12	PCS
	J05	12	PCS

Part	NO.	QTY.	Length(MM)	CTN NO.
	40X-Y31R-11D	1	197	3281P-S-1
	40X-Y31L-11D	1	197	3281P-S-1
	40X-Y31R-11E	1	343	3281P-S-1
	40X-Y31L-11E	1	343	3281P-S-1
	40X-Y31R-11F	1	488	3281P-S-1
	40X-Y31L-11F	1	488	3281P-S-1
	Si6-16	12	PCS	3281P-S-1
	J05	12	PCS	3281P-S-1

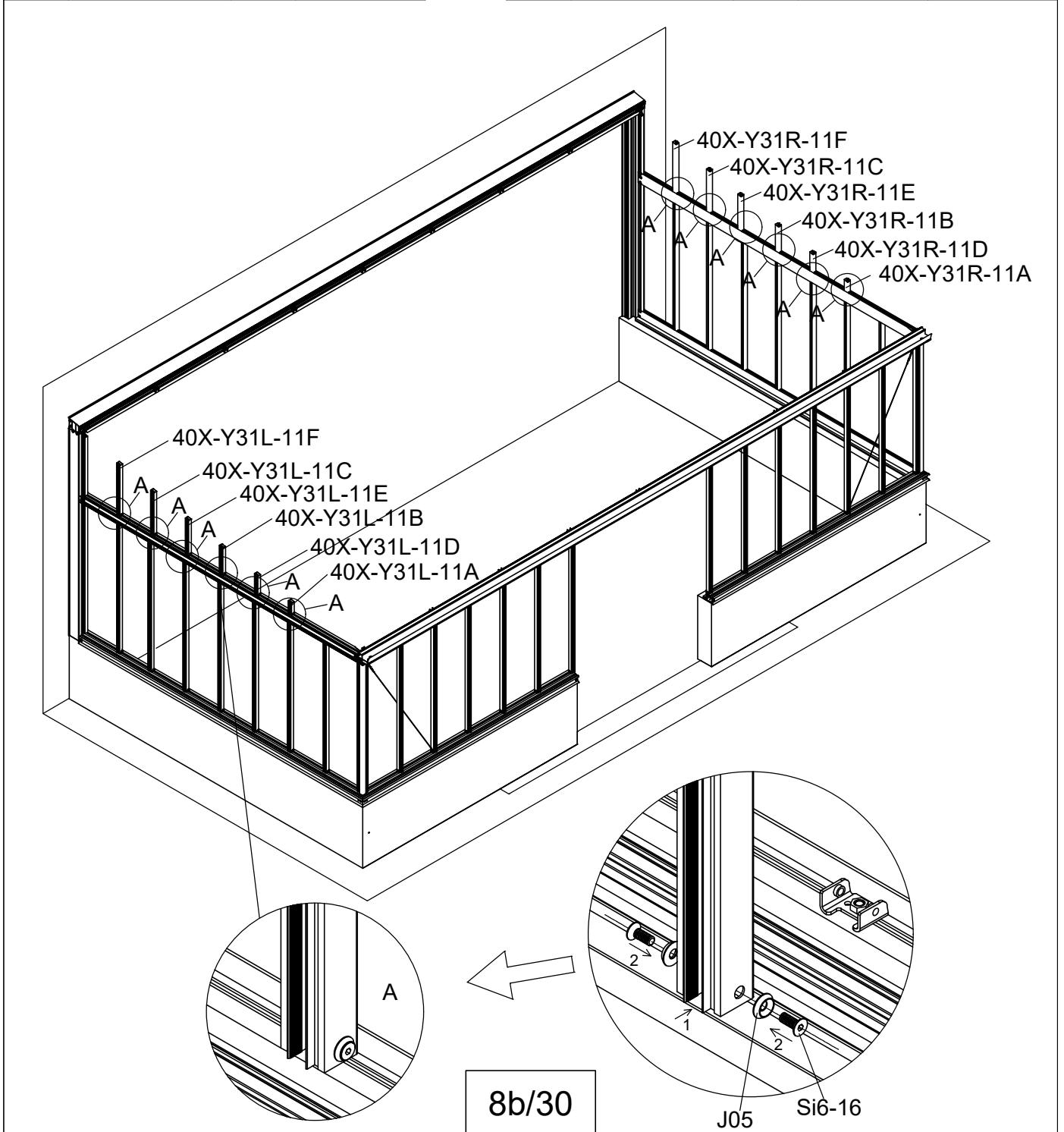



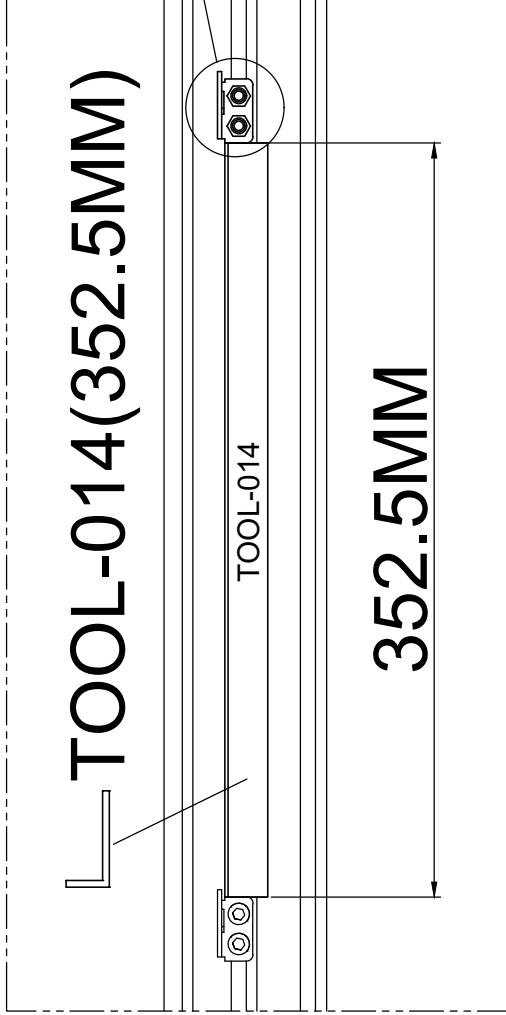
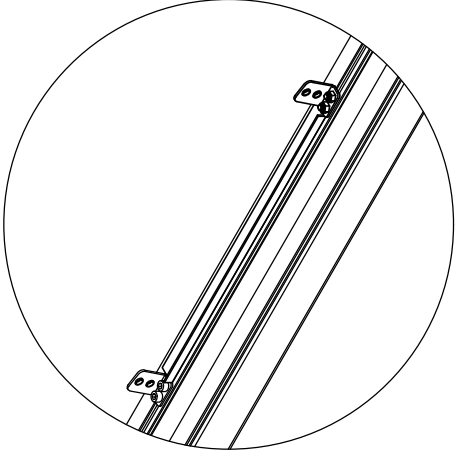
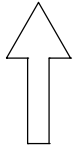
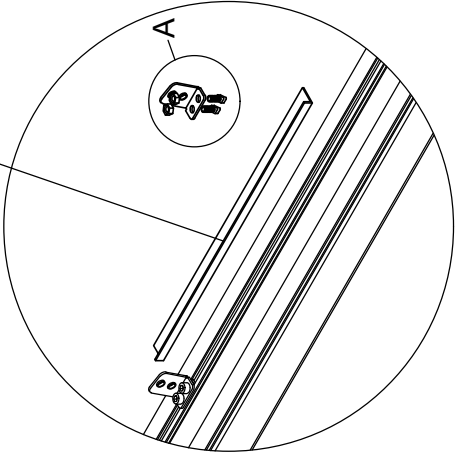

L TOOL-014(352.5MM)

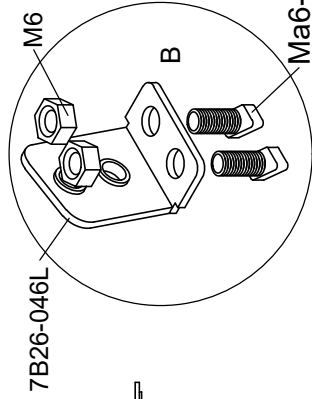
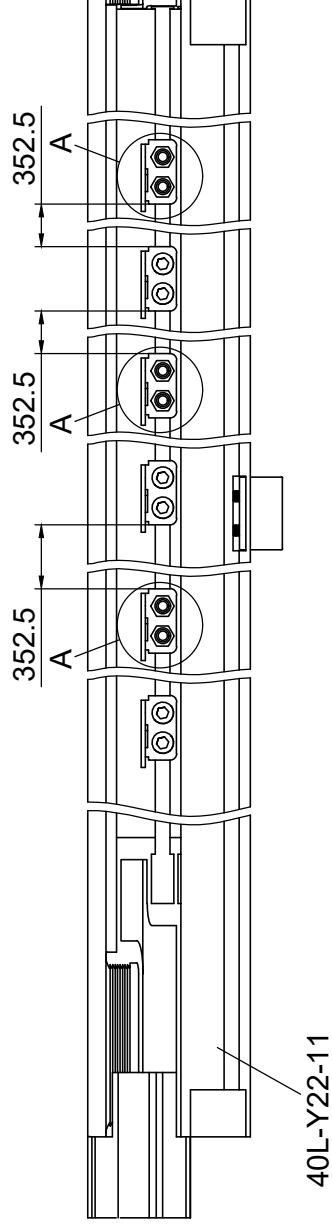
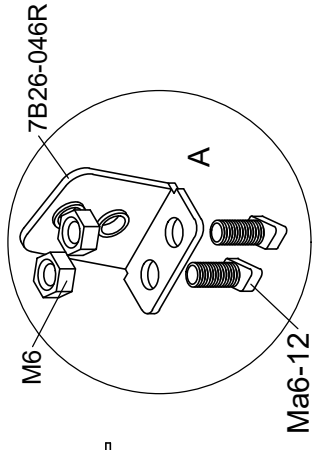
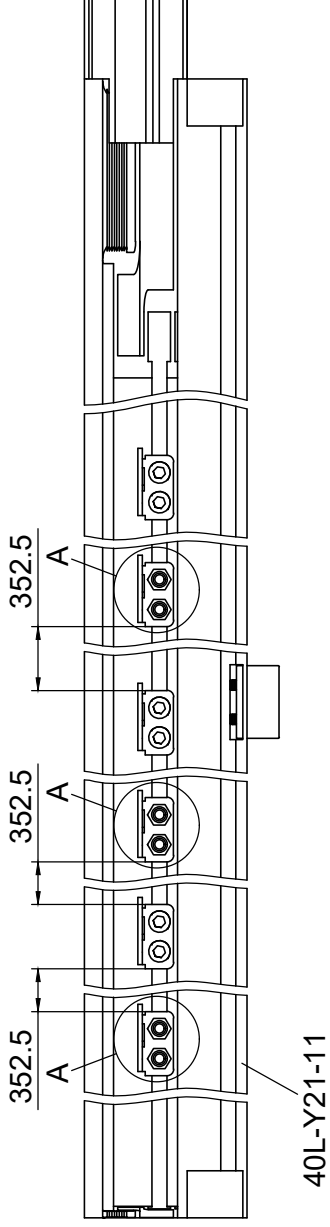

Part	NO.	QTY.	Length(MM)
	40L-Y21-11	1	3118
	40L-Y22-11	1	3118



Part	NO.	QTY.	Length(MM)	CTN NO.
	7B26-046R	3	PCS	3281P-S-1
	7B26-046L	3	PCS	3281P-S-1
	Ma6-12	12	PCS	3281P-S-1
	M6	12	PCS	3281P-S-1



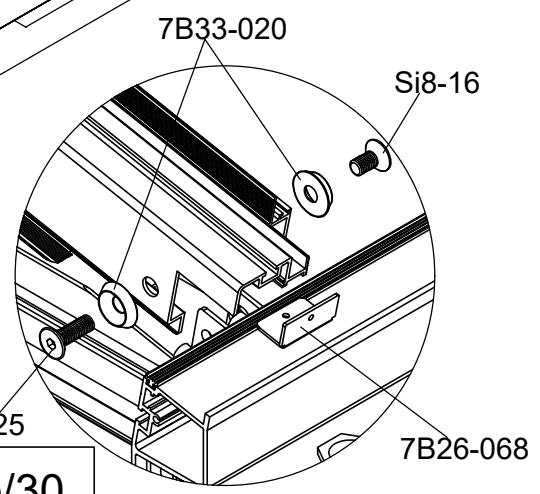
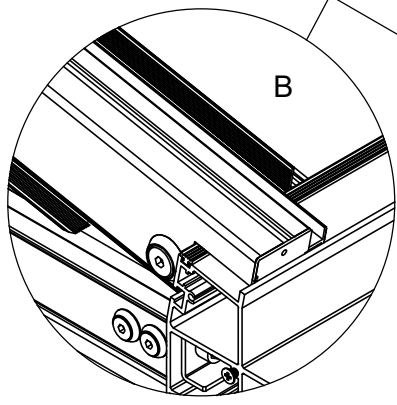
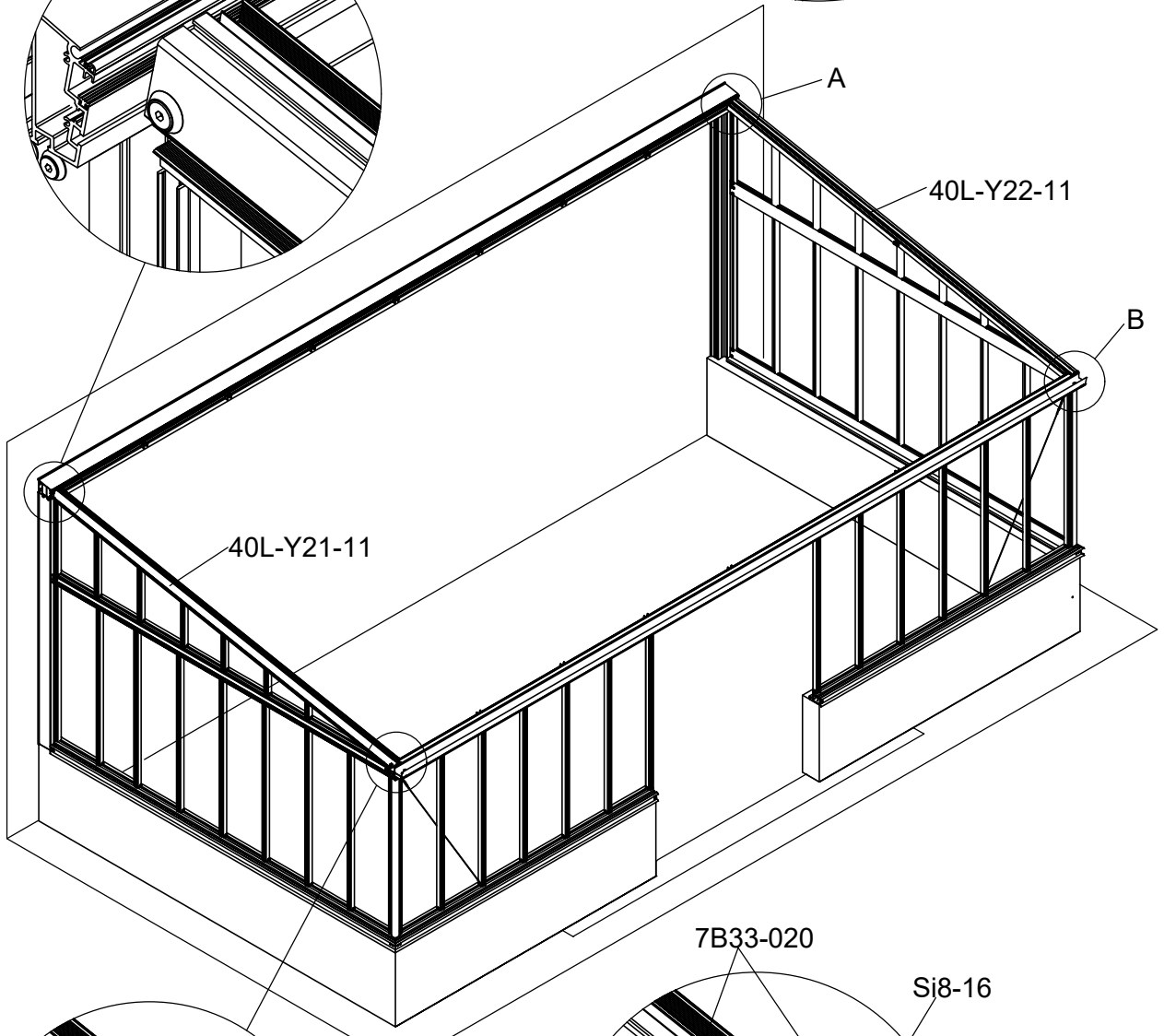
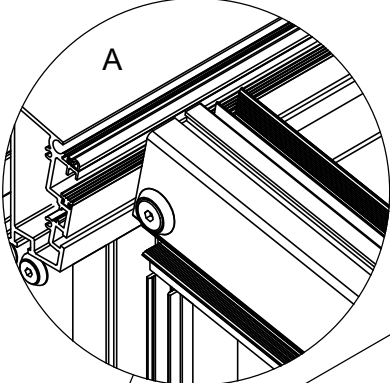
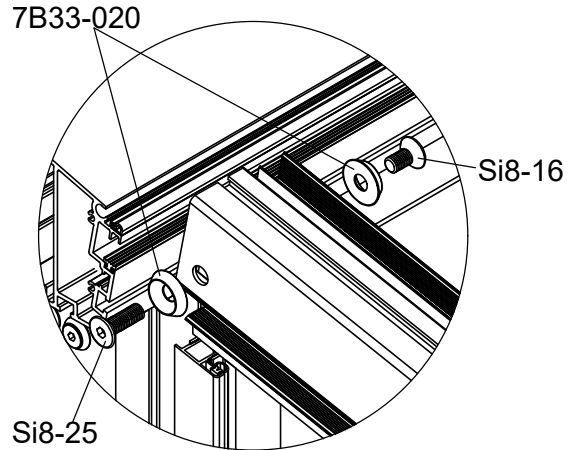





Part	NO.	QTY.	Length(MM)
	7B26-068	2	PCS
	Si8-25	4	PCS
	7B33-020	8	PCS
	Si8-16	4	PCS

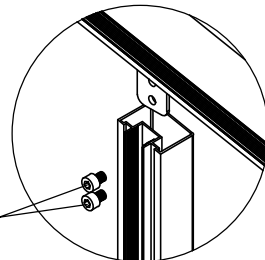
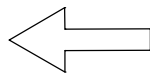
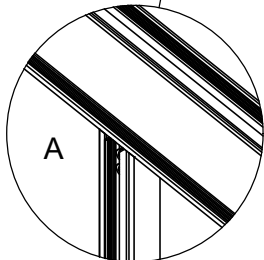
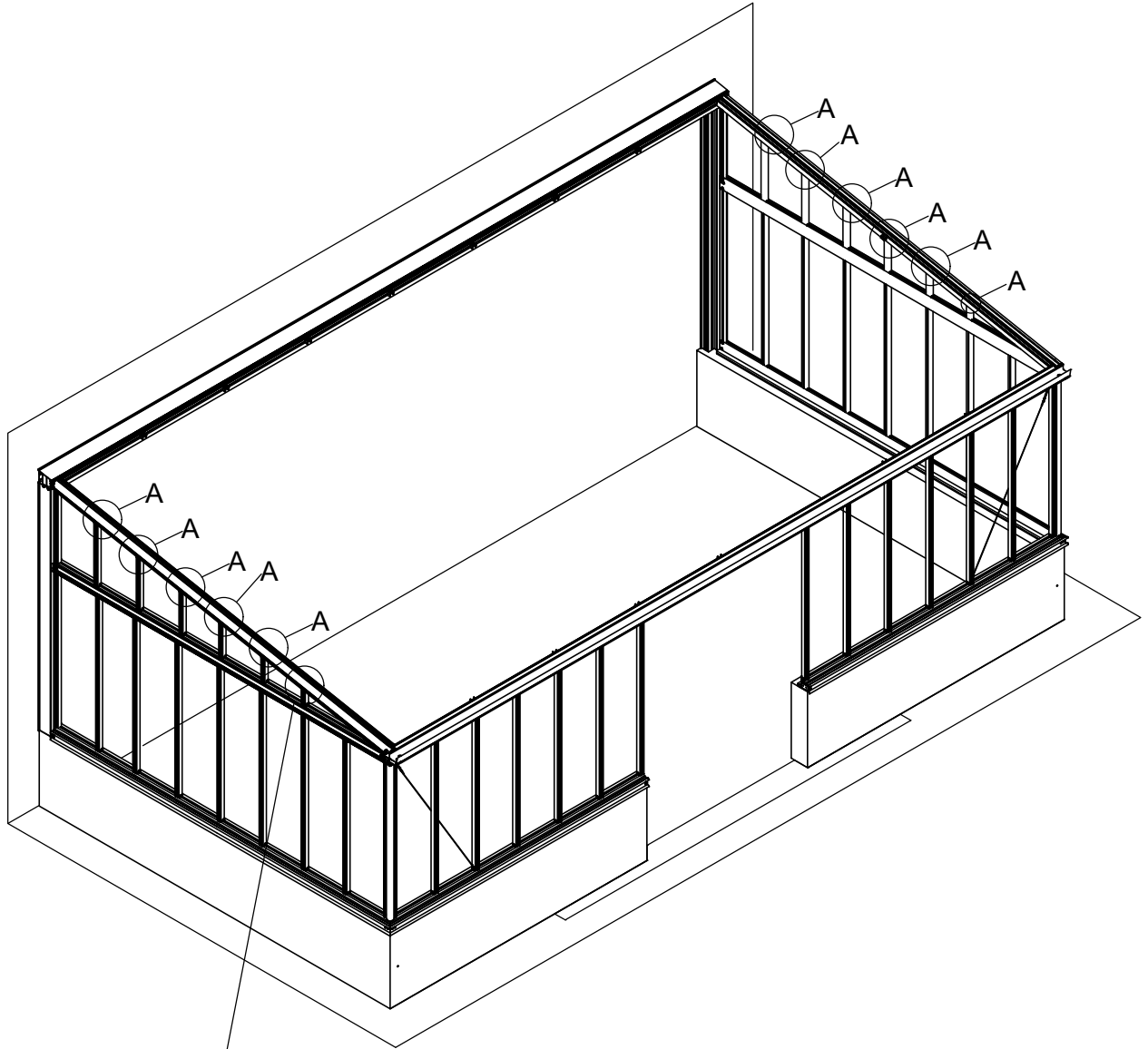



8e/30

Part	NO.	QTY.	Length(MM)	CTN NO.
	M6-8	12	PCS	
	M6-8	12	PCS	3281P-S-1

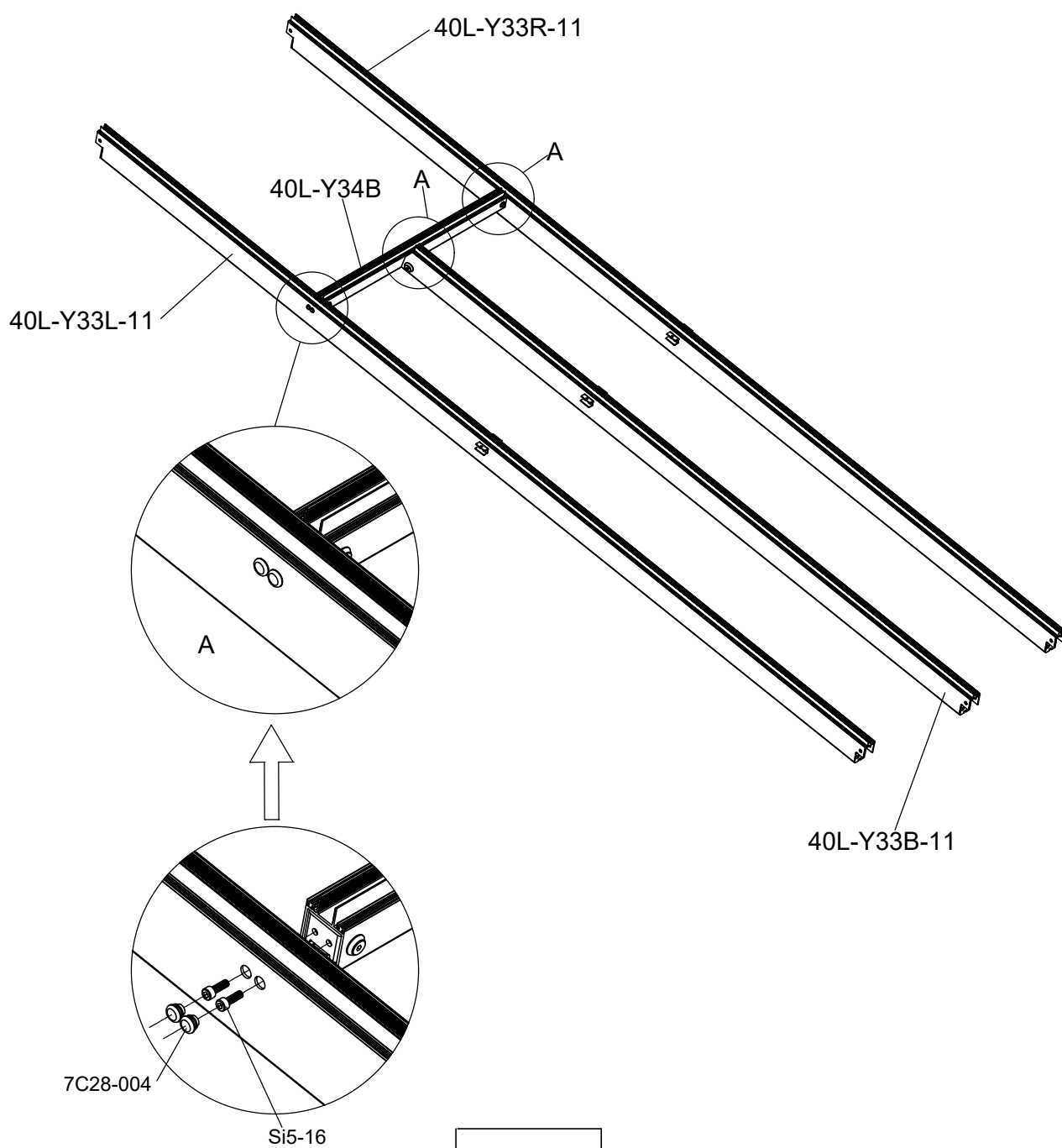

Part	NO.	QTY.															Length (MM)
		3281			3282			3283			3284			3285			
		3281	3281P-S-1	3281P-S-2	3282	3281P-S-1	3281P-S-2	3283	3281P-S-1	3281P-S-2	3284	3281P-S-1	3281P-S-2	3285	3281P-S-1	3281P-S-2	
	40L-Y33R-11	1	0	0	2	0	0	2	0	0	3	0	0	3	0	0	3079
	40L-Y33L-11	1	0	0	2	0	0	2	0	0	3	0	0	3	0	0	3079
	40L-Y33B-11	0	1	0	0	1	1	0	1	1	0	1	2	0	1	2	2202
	40L-Y34B	0	1	0	0	1	1	0	1	1	0	1	2	0	1	2	713
	Si5-16	4	2	0	8	2	2	8	2	2	12	2	4	12	2	4	PCS
	7C28-004	4	2	0	8	2	2	8	2	2	12	2	4	12	2	4	PCS





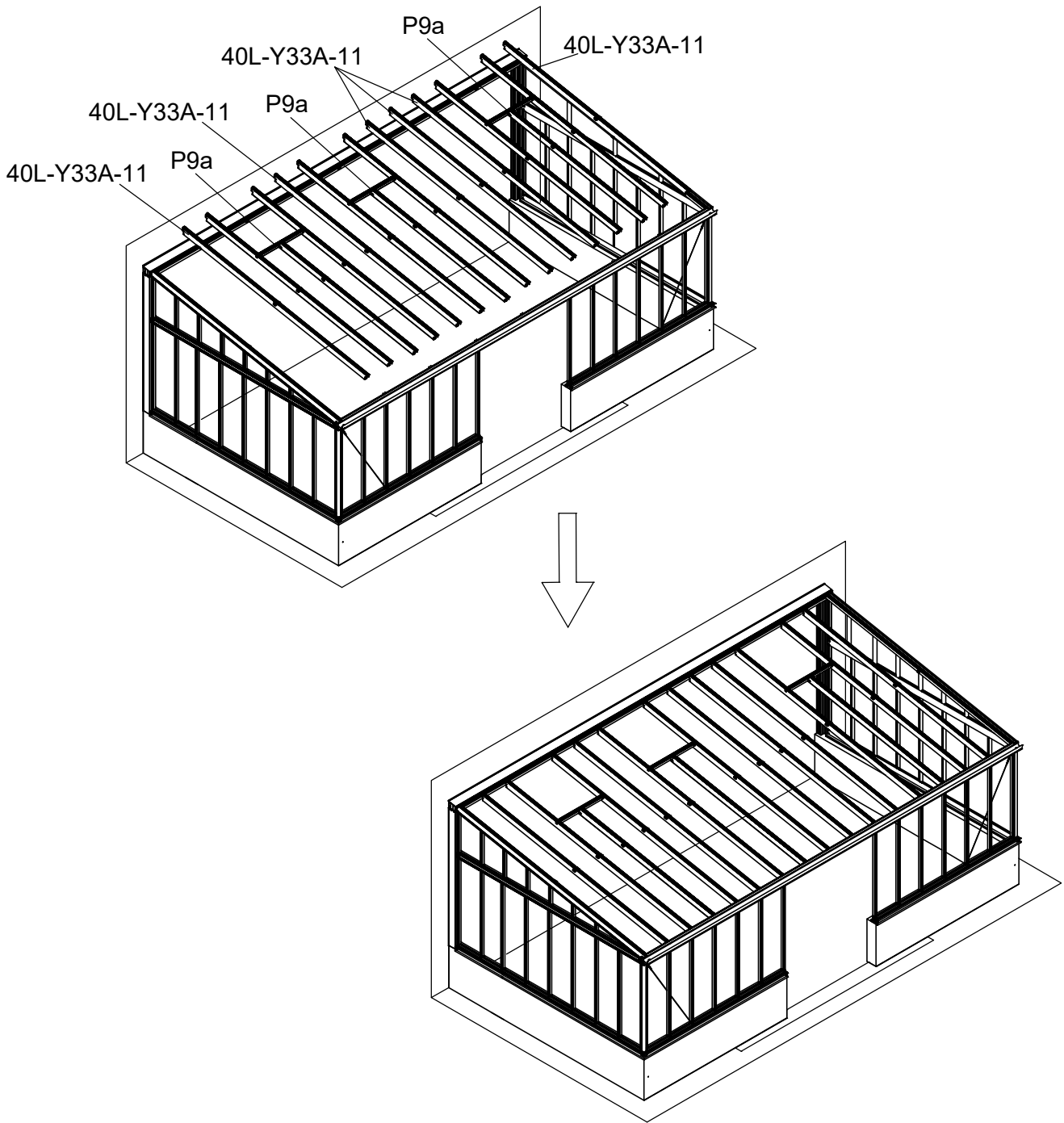

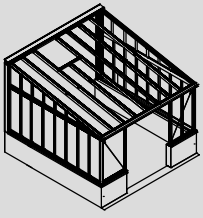
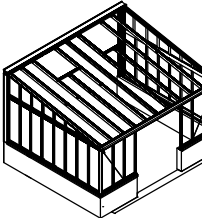
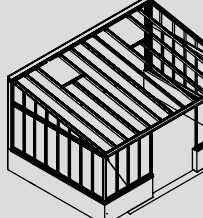
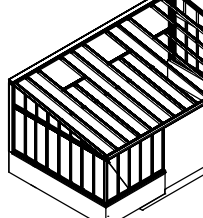
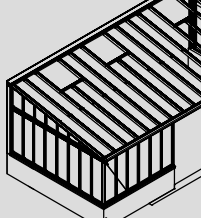
Part	NO.	QTY.														Length (MM)	
		3281			3282			3283			3284			3285			
		3281	3281P-S-1	3281P-S-2	3282	3281P-S-1	3281P-S-2	3283	3281P-S-1	3281P-S-2	3284	3281P-S-1	3281P-S-2	3285	3281P-S-1		3281P-S-2
	40L-Y33A-11	1	3	0	0	3	0	1	3	1	0	3	1	1	3	2	3079

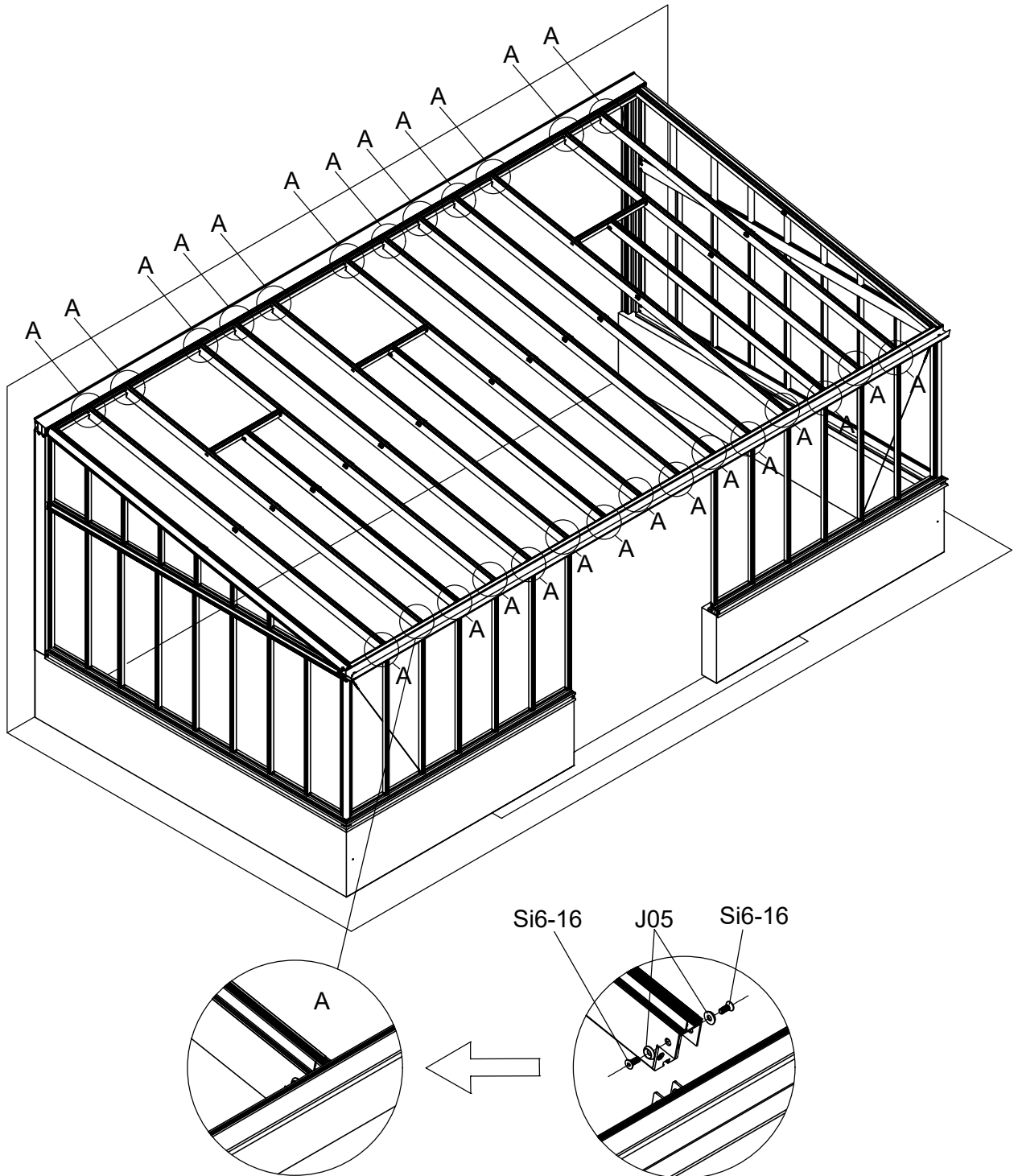

3281	3282	3283	3284	3285
				

Part	NO.	QTY.															Length (MM)
		3281			3282			3283			3284			3285			
		3281	3281P-S-1	3281P-S-2	3282	3281P-S-1	3281P-S-2	3283	3281P-S-1	3281P-S-2	3284	3281P-S-1	3281P-S-2	3285	3281P-S-1	3281P-S-2	
⊕	Si6-16	12	14	0	16	14	2	20	14	6	24	14	8	28	14	12	PCS
⊙	J05	12	14	0	16	14	2	20	14	6	24	14	8	28	14	12	PCS



Part	NO.	QTY.															Length (MM)
		3281			3282			3283			3284			3285			
		3281	3281P-S-1	3281P-S-2	3282	3281P-S-1	3281P-S-2	3283	3281P-S-1	3281P-S-2	3284	3281P-S-1	3281P-S-2	3285	3281P-S-1	3281P-S-2	
	40L-Y36N3	0	2	0	0	2	0	0	2	0	0	2	0	0	2	0	335
	40L-Y36N3	0	6	0	0	6	2	0	6	4	0	6	6	0	6	8	337
	M6-8	8	8	0	10	8	2	12	8	4	14	8	6	16	8	8	PCS

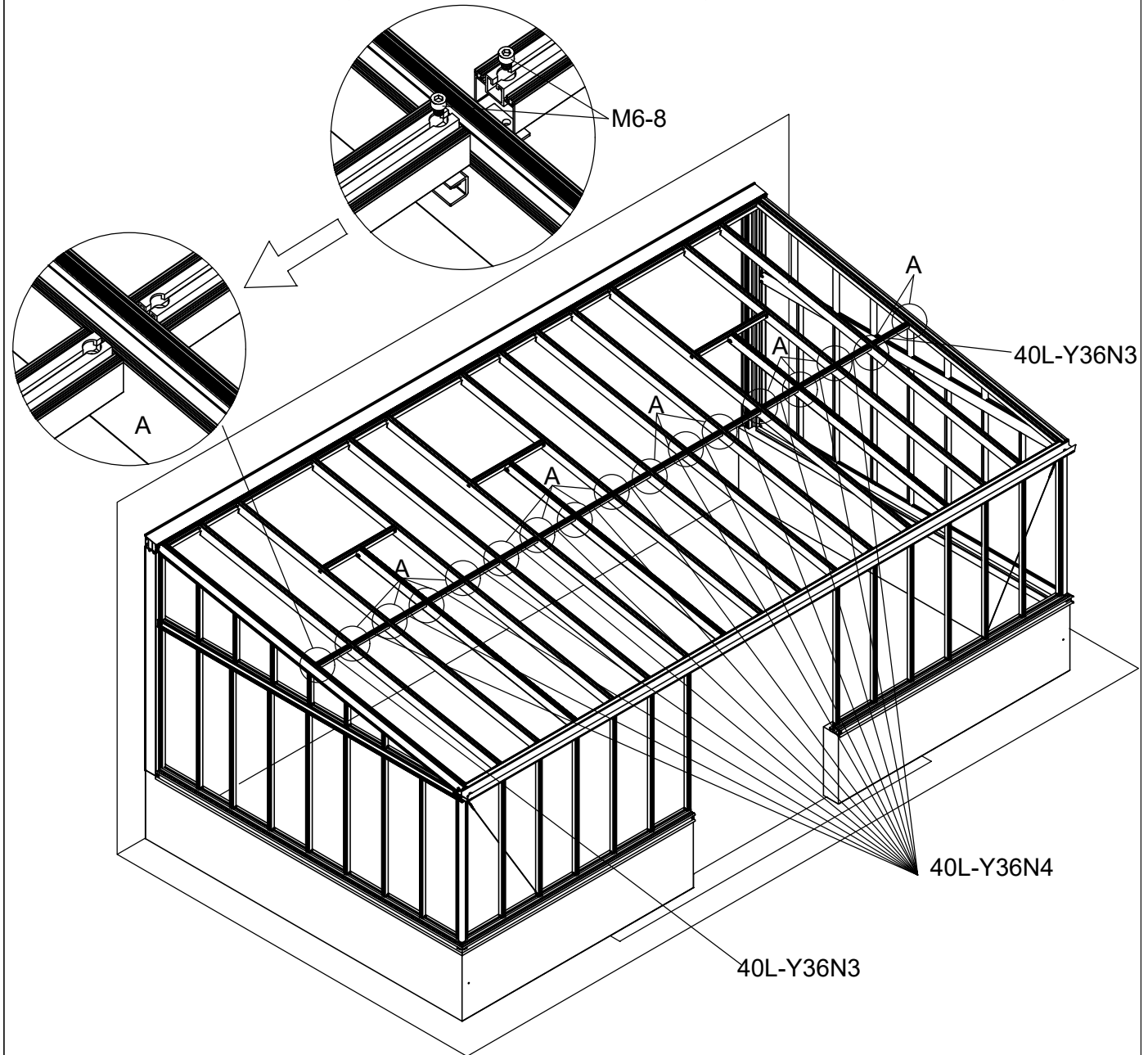

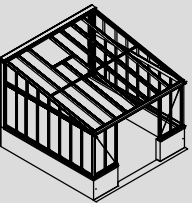
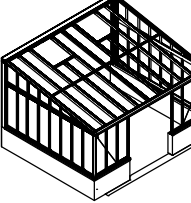
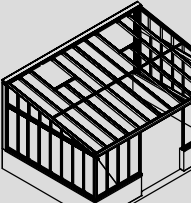
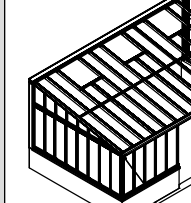
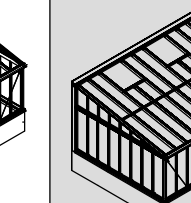
3281	3282	3283	3284	3285
				

Part	NO.	QTY.					Length(MM)
		3281	3282	3283	3284	3285	
	354×1262	12	14	16	18	20	1262

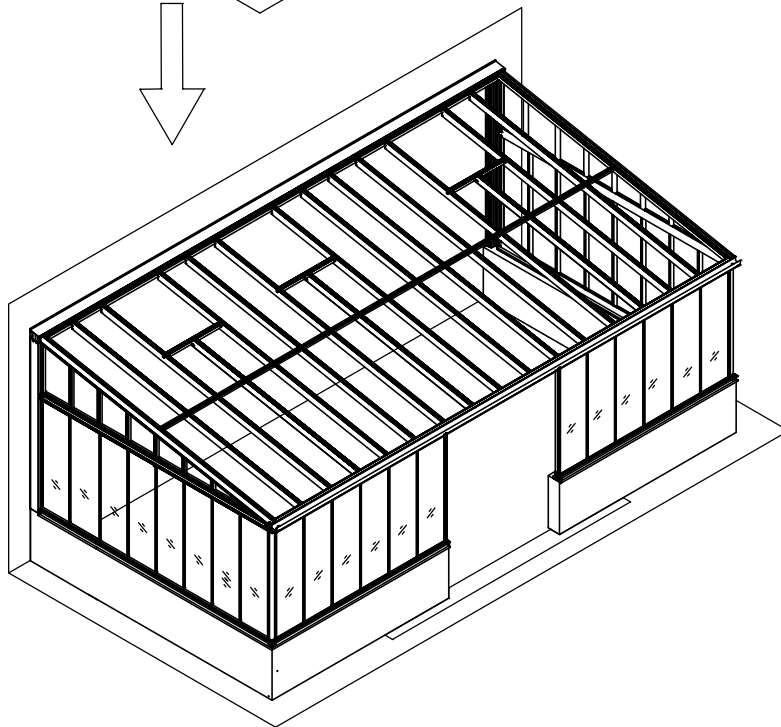
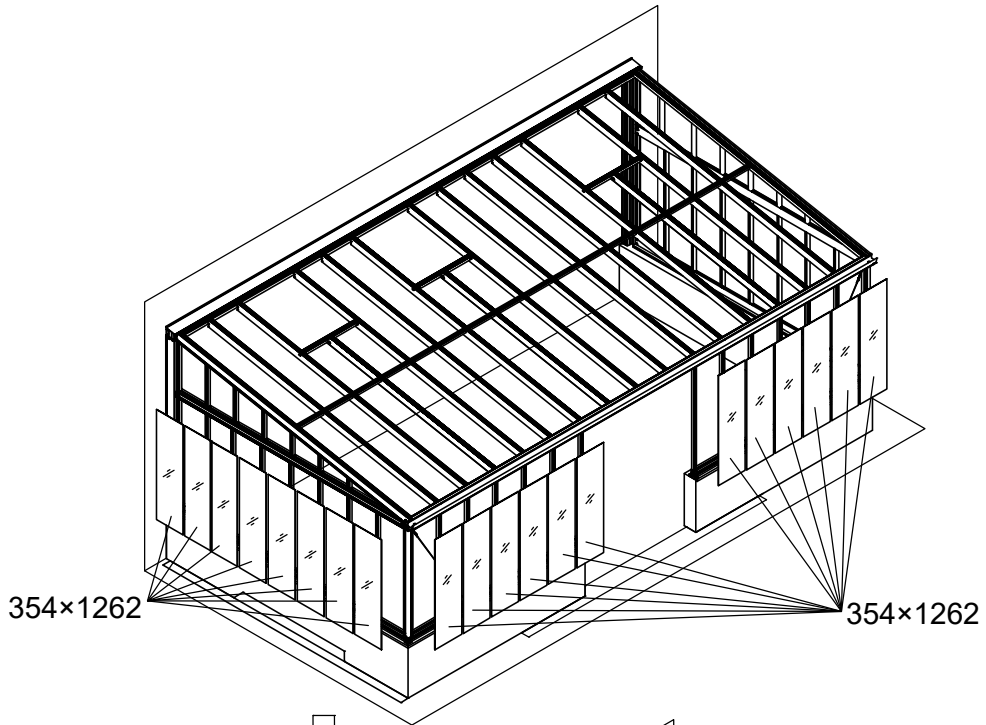

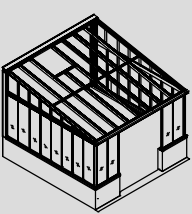
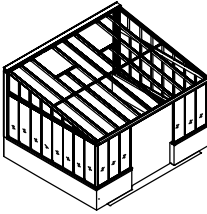
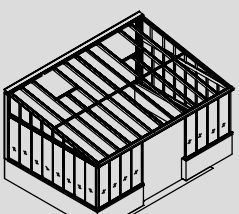
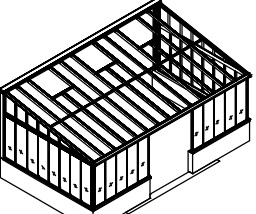
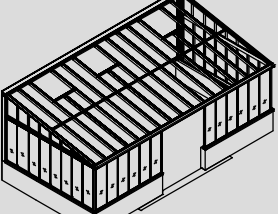

3281	3282	3283	3284	3285
				

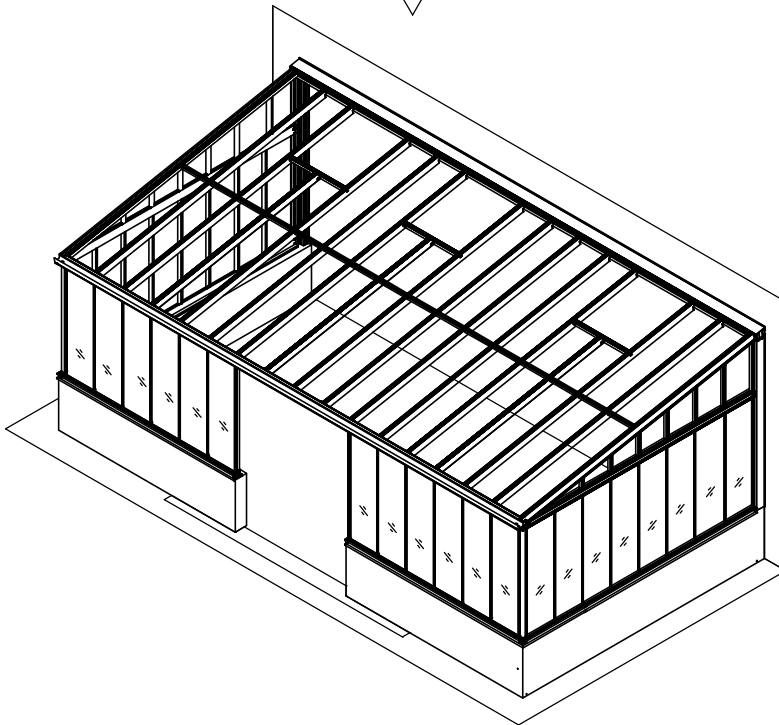
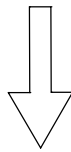
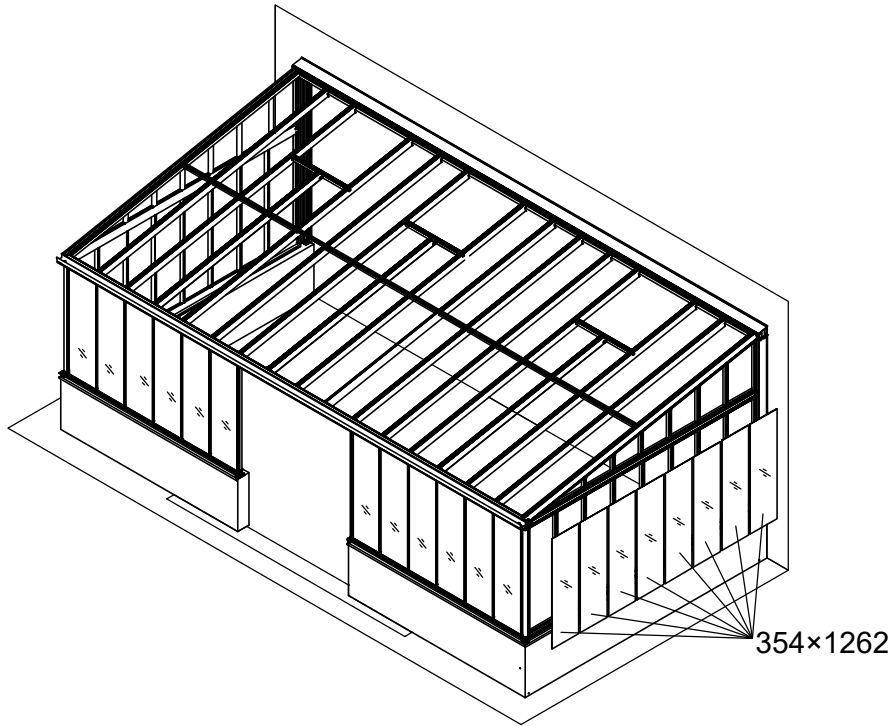
Part	NO.	QTY.	Length(MM)
	354×1262	8	1262



10b/30

Part	Product	NO.	Length(MM)	QTY.	CTN NO.	Code
A013	3281	40A-Y15-R	842	1	3043PA-S-4	A013
	3282	50A-Y15-R	1218	1	3171P-S-5D	
	3283	40A-S15-6R	1593	1	3171P-S-6D	
	3284	40A-S15-7R	1969	1	3171P-S-7D	
	3285	40A-S15-8R	2344	1	3171P-S-8D	
A014	3281	40A-Y15-L	842	1	3043PA-S-4	A014
	3282	50A-Y15-L	1218	1	3171P-S-5D	
	3283	40A-S15-6L	1593	1	3171P-S-6D	
	3284	40A-S15-7L	1969	1	3171P-S-7D	
	3285	40A-S15-8L	2344	1	3171P-S-8D	

Part	NO.	Length(MM)	QTY.	CTN NO.
	40L-S15R-4	3086	1	3171P-S-BASE4R
	40L-S15L-4	3086	1	3171P-S-4F

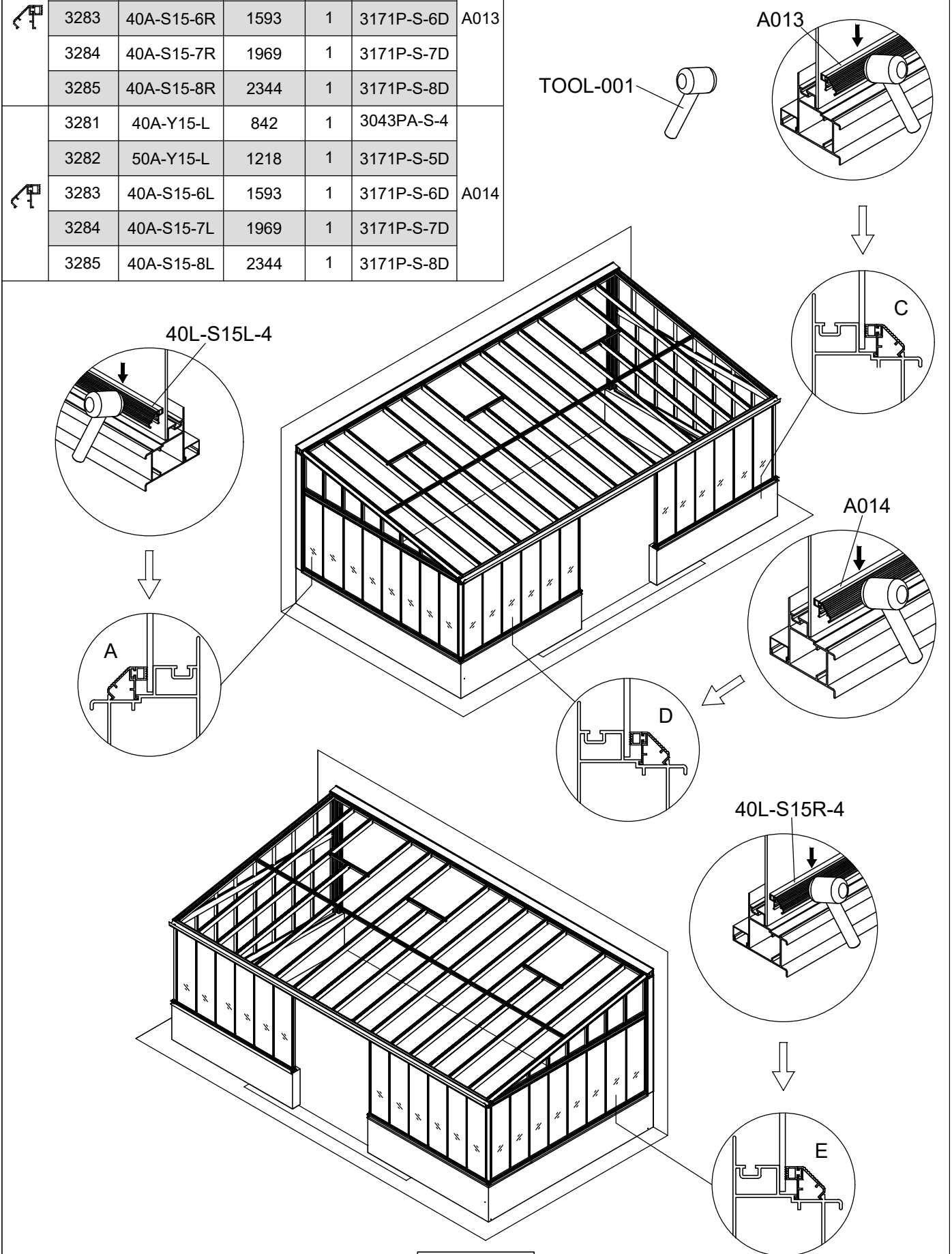

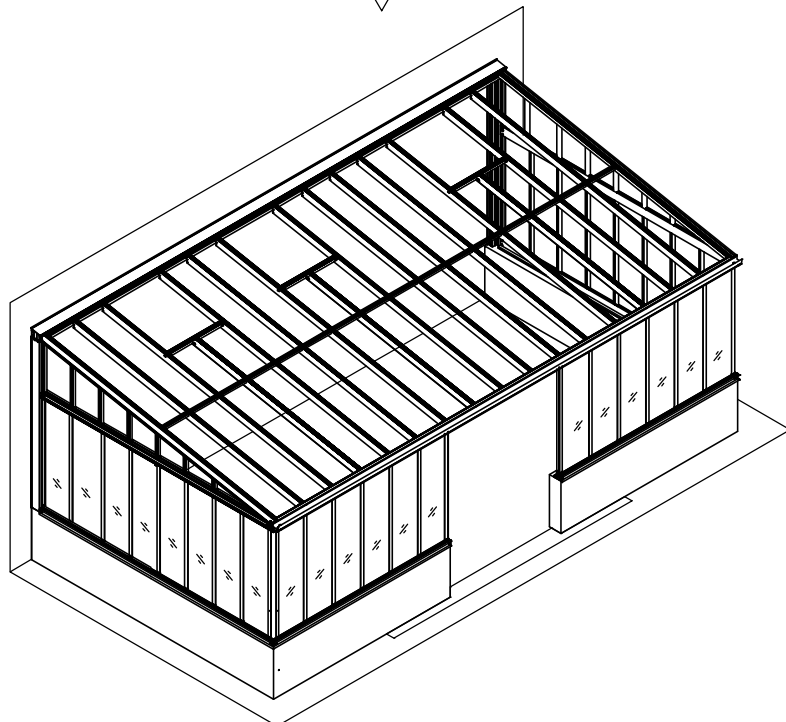
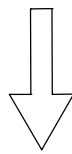
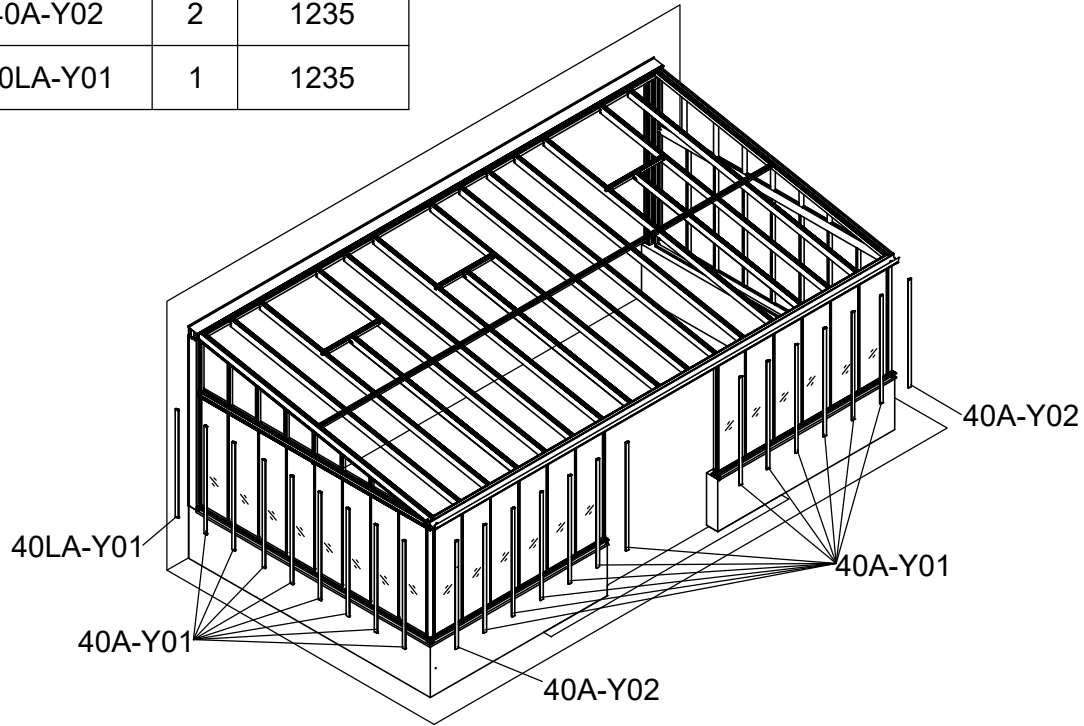

Part	NO.	QTY.															Length (MM)
		3281			3282			3283			3284			3285			
		3281	3281P-S-1	3281P-S-2	3282	3281P-S-1	3281P-S-2	3283	3281P-S-1	3281P-S-2	3284	3281P-S-1	3281P-S-2	3285	3281P-S-1	3281P-S-2	
40A-Y01		6	6	0	7	6	1	8	6	2	9	6	3	10	6	4	1235

Part	NO.	QTY.	Length(MM)
40A-Y02		2	1235
40LA-Y01		1	1235

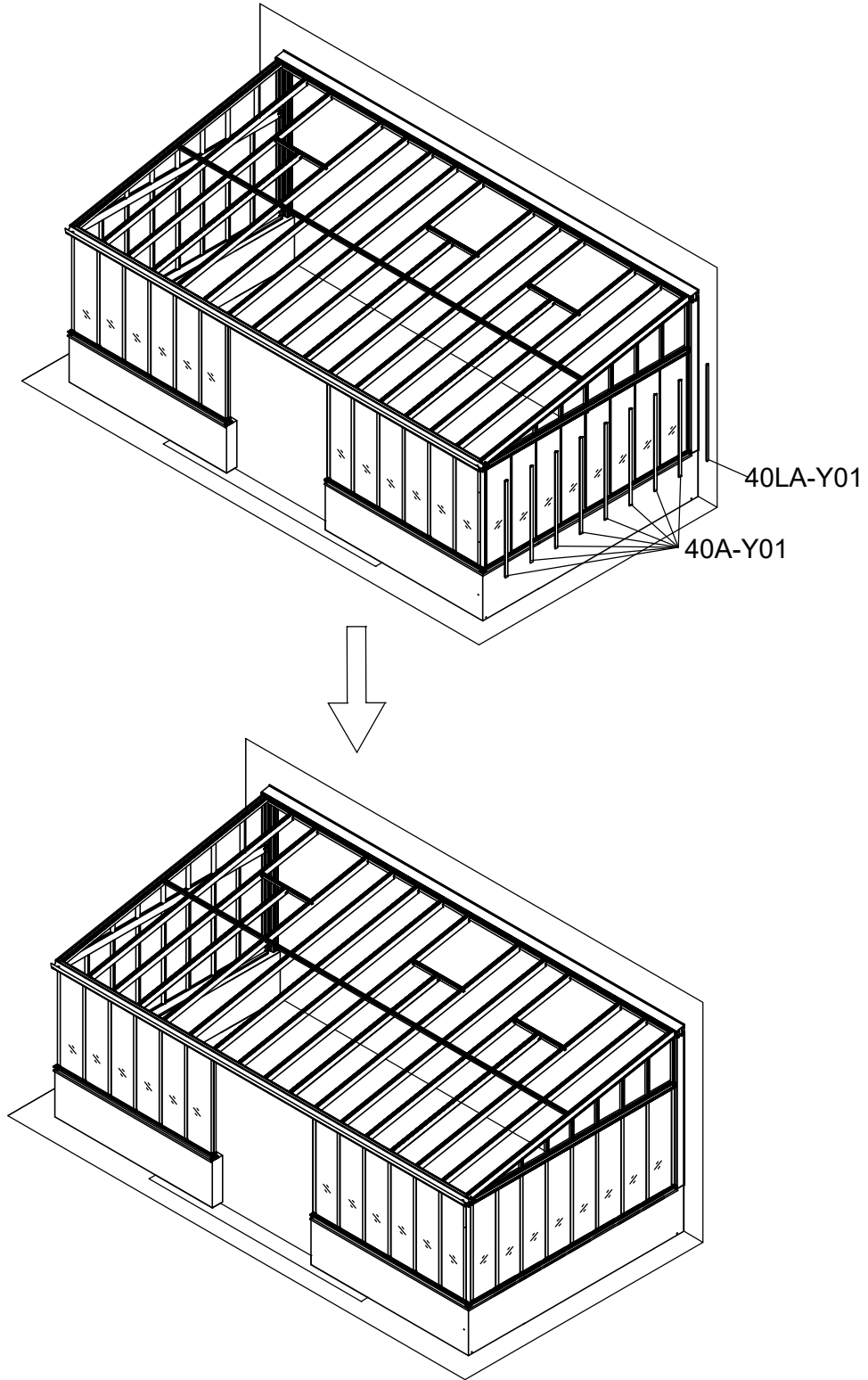

Part	NO.	QTY.	Length(MM)	CTN NO.
୩୮	40A-Y01	4	1235	
୩୮	40A-Y01	4	1235	3281P-S-1
୩୯	40LA-Y01	1	1235	



Part	NO.	QTY.					Length(MM)
		3281	3282	3283	3284	3285	
	7C26-007N	9.5M	10.3M	11M	11.8M	12.5M	

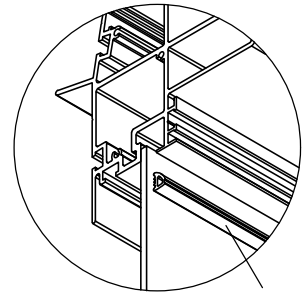
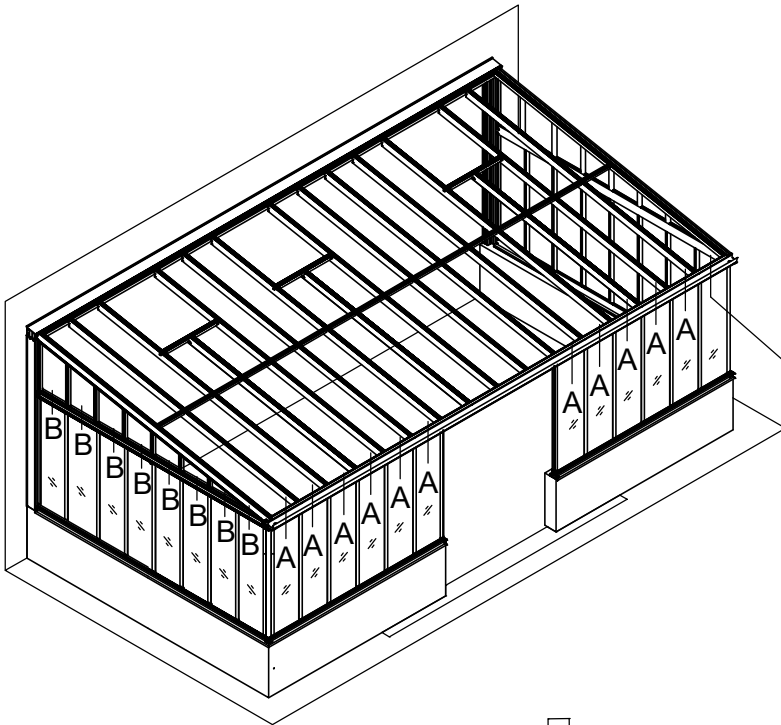



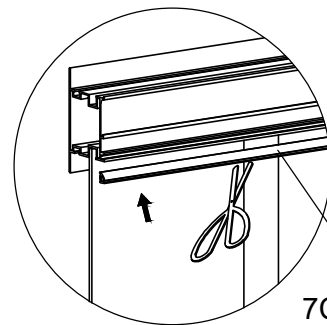
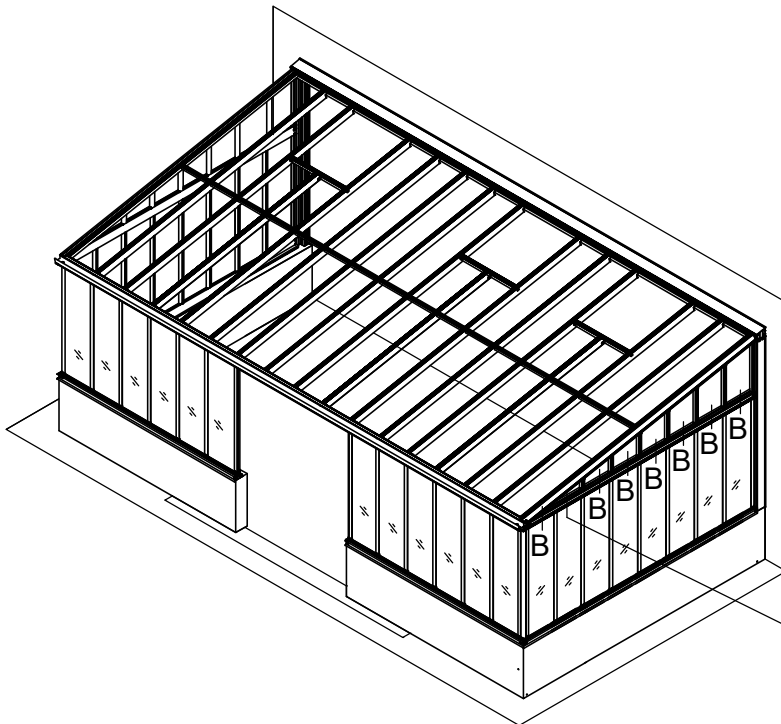
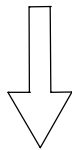
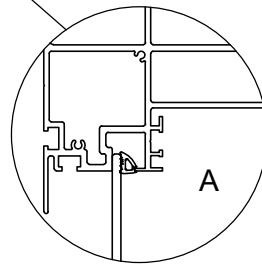
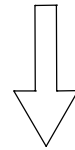

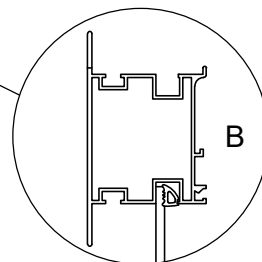
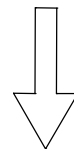

7C26-007N



7C26-007N





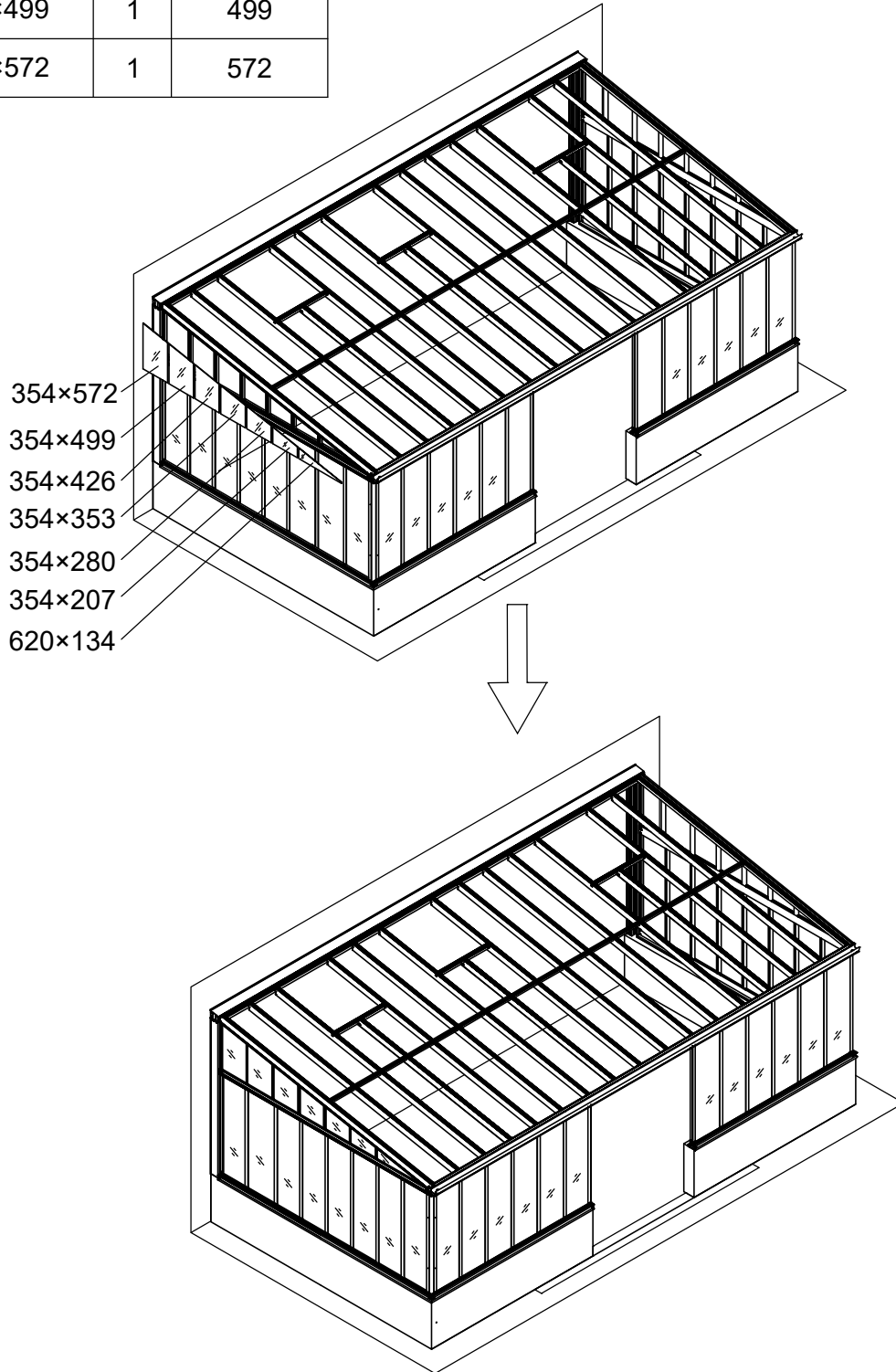



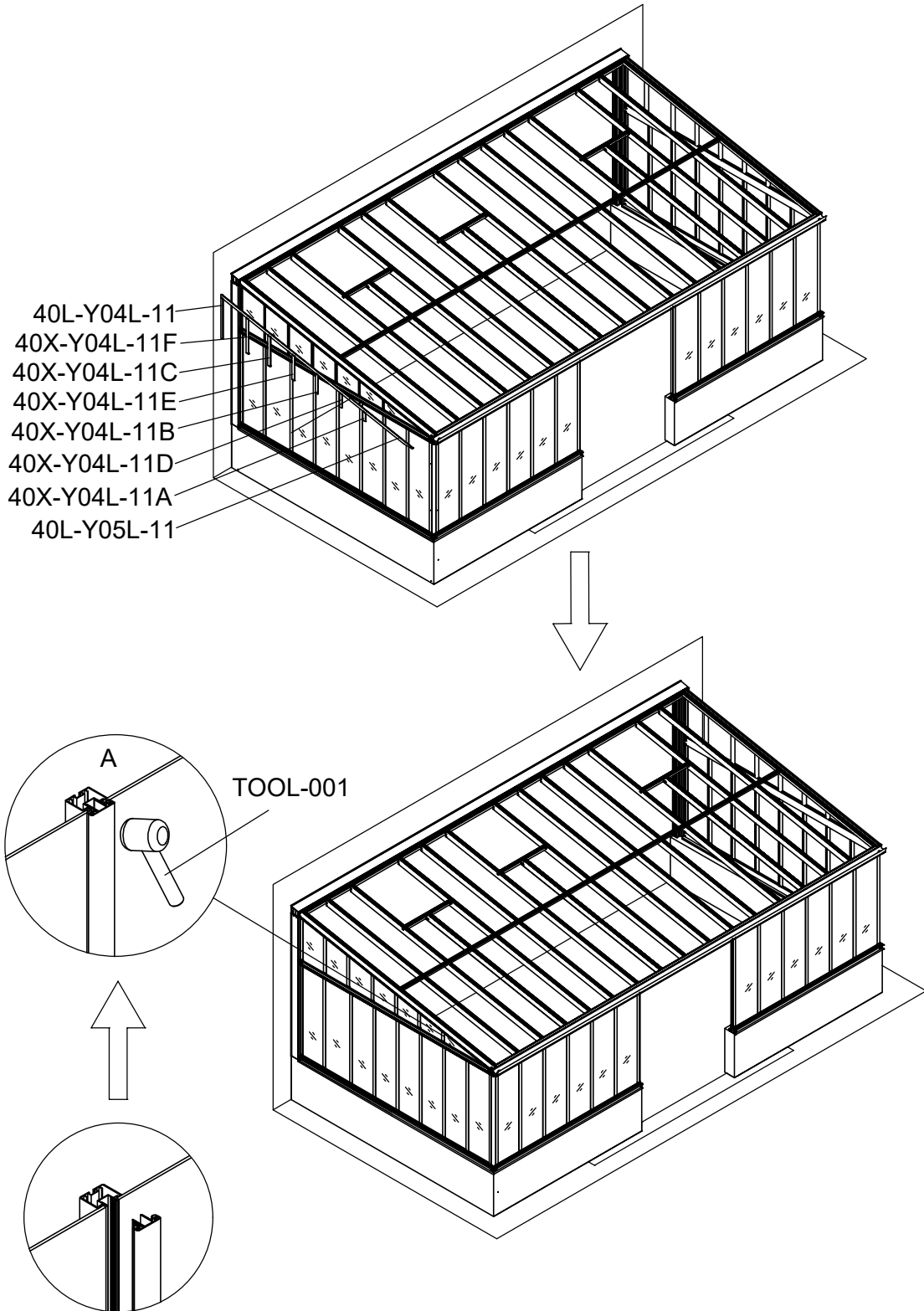

Part	NO.	QTY.	Length(MM)
	620×134	1	620
	354×207	1	354
	354×280	1	354
	354×353	1	354
	354×426	1	426
	354×499	1	499
	354×572	1	572







Part	NO.	QTY.	Length(MM)
	40L-Y05L-11	1	3080
	40X-Y04L-11C	1	416
	40X-Y04L-11B	1	270
	40X-Y04L-11A	1	124
	40L-Y04L-11	1	560

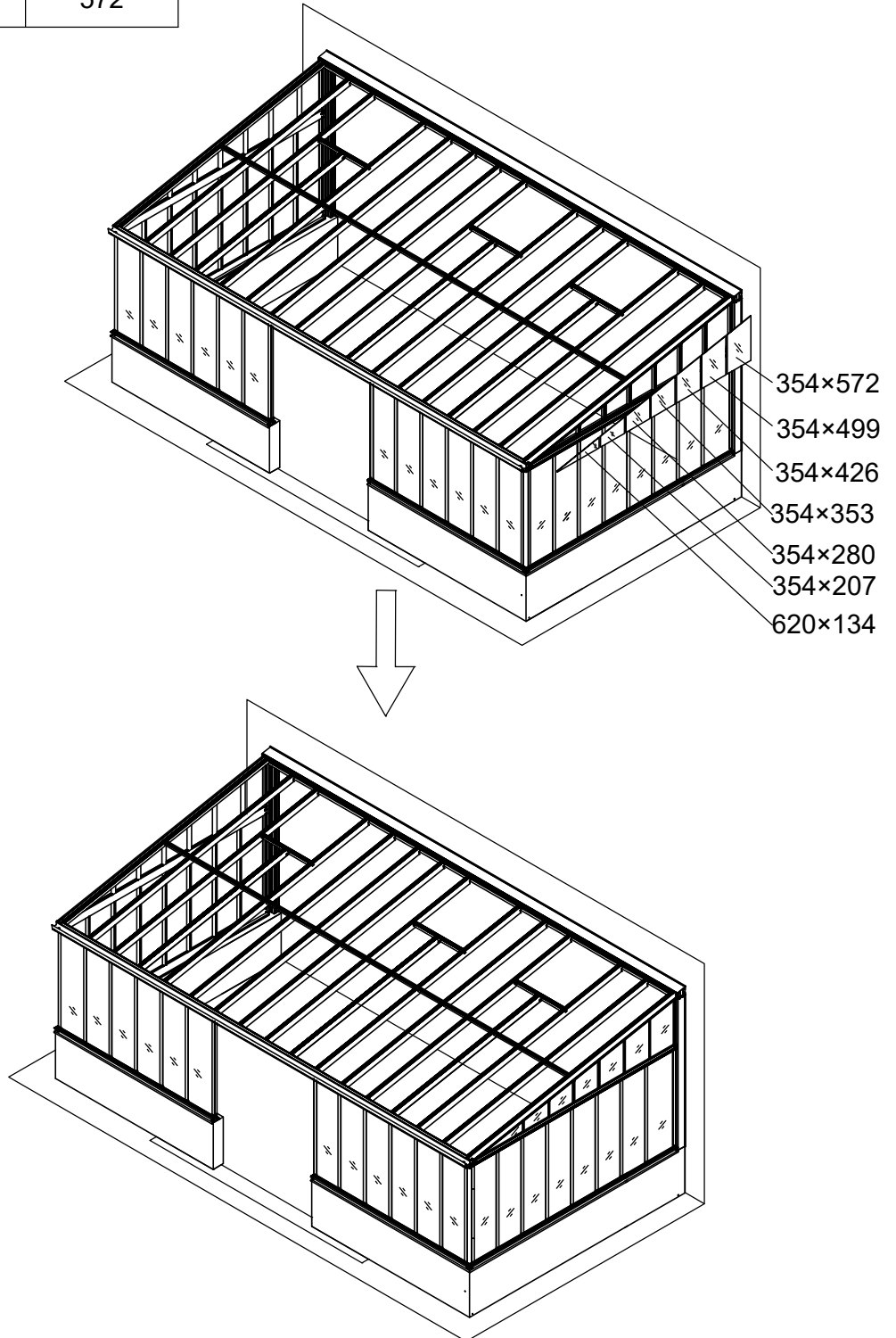

Part	NO.	QTY.	Length(MM)	CTN NO.
	40X-Y04L-11D	1	197	3281P-S-1
	40X-Y04L-11E	1	343	3281P-S-1
	40X-Y04L-11F	1	489	3281P-S-1





Part	NO.	QTY.	Length(MM)
	620×134	1	620
	354×207	1	354
	354×280	1	354
	354×353	1	354
	354×426	1	426
	354×499	1	499
	354×572	1	572



Part	NO.	QTY.	Length(MM)
	40L-Y05R-11	1	3080
	40X-Y04R-11C	1	416
	40X-Y04R-11B	1	270
	40X-Y04R-11A	1	124
	40L-Y04R-11	1	560

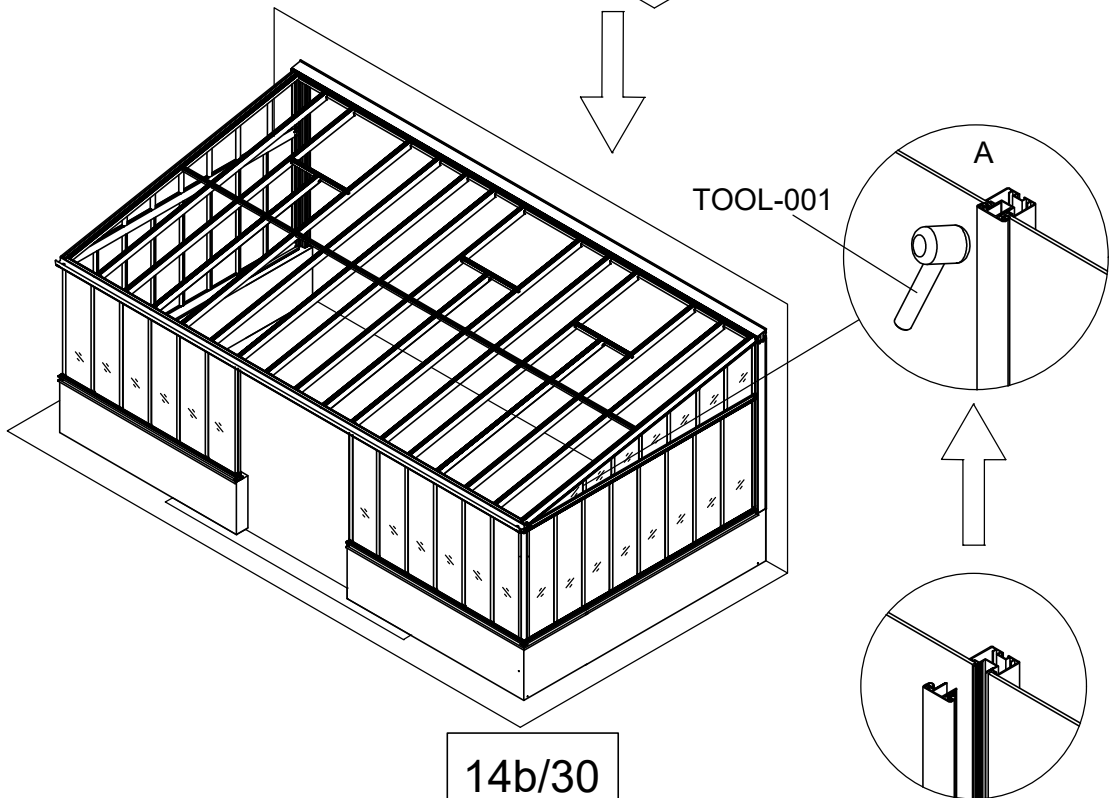
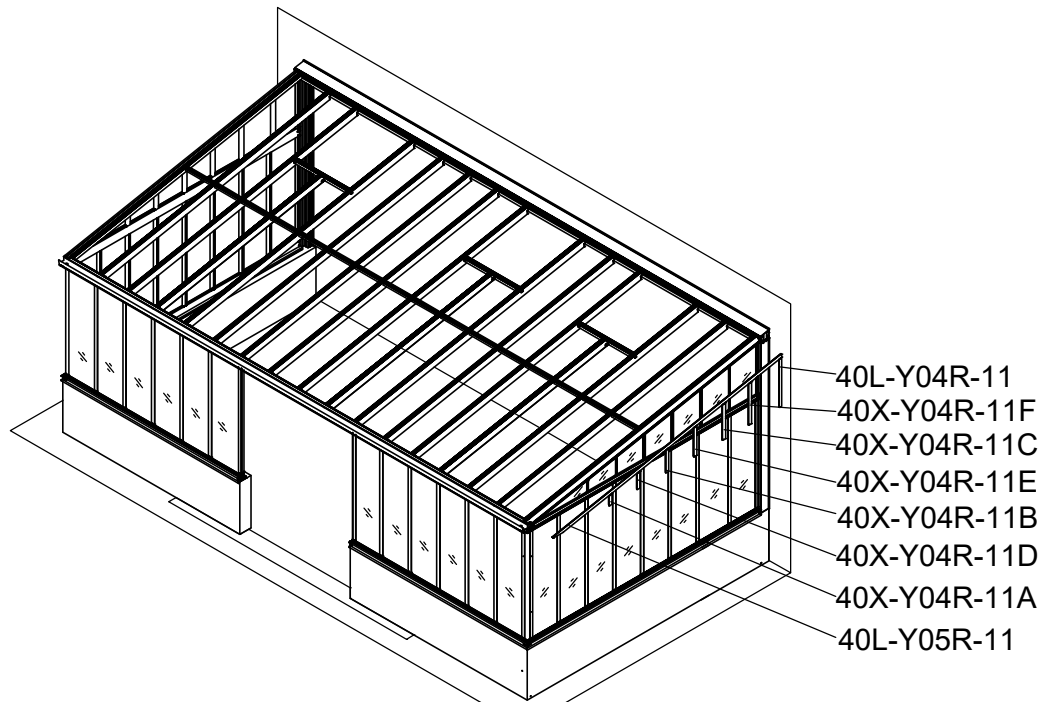



Part	NO.	QTY.	Length(MM)	CTN NO.
	40X-Y04R-11D	1	197	3281P-S-1
	40X-Y04R-11E	1	343	3281P-S-1
	40X-Y04R-11F	1	489	3281P-S-1

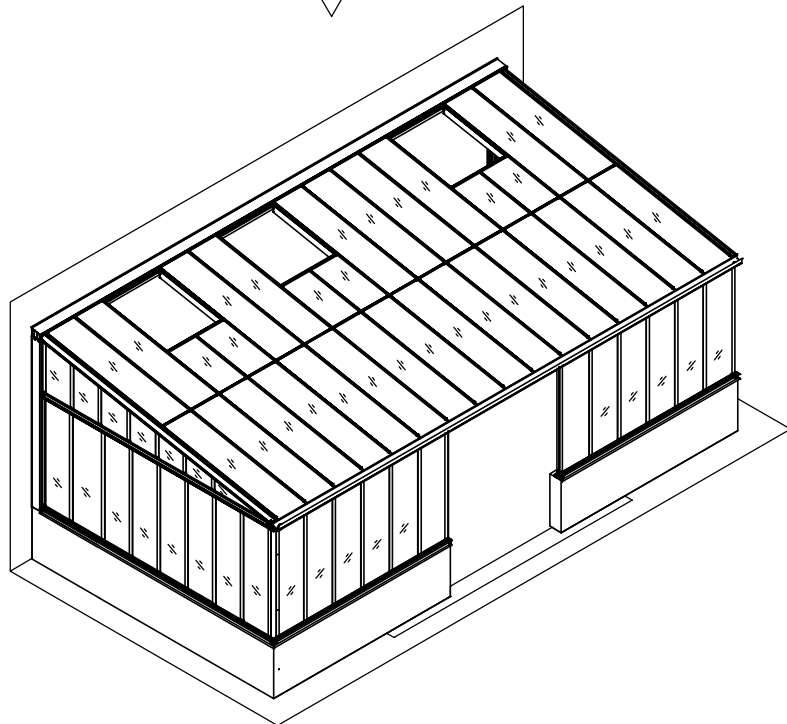
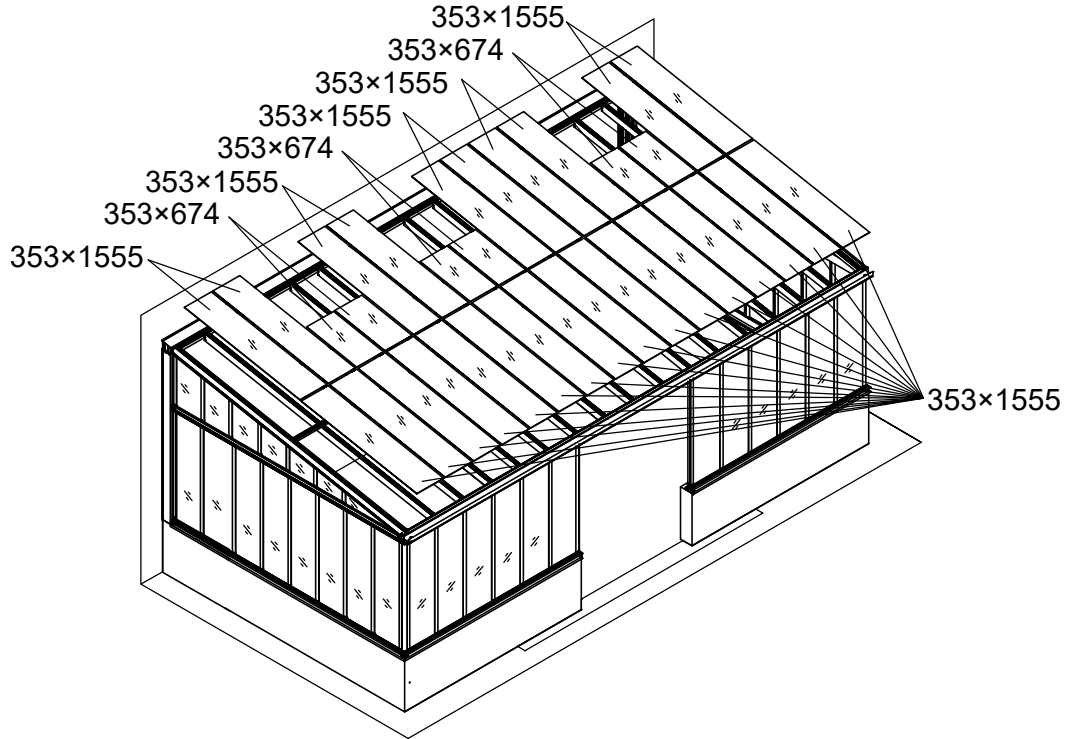

Part	NO.	QTY.					Length(MM)
		3281	3282	3283	3284	3285	
	353×1555	14	16	20	22	26	1555
	353×674	2	4	4	6	6	674



15a/30

Part	NO.	QTY.															Length (MM)
		3281			3282			3283			3284			3285			
		3281	3281P-S-1	3281P-S-2	3282	3281P-S-1	3281P-S-2	3283	3281P-S-1	3281P-S-2	3284	3281P-S-1	3281P-S-2	3285	3281P-S-1	3281P-S-2	
	40L-Y06-11	5	3	0	6	3	0	7	3	1	8	3	1	9	3	2	3118
	40L-Y07	1	0	0	2	0	0	2	0	0	3	0	0	3	0	0	713
	40L-Y06A-11	0	1	0	0	1	1	0	1	1	0	1	2	0	1	2	2240
	7B26-069	5	4	0	6	4	1	7	4	2	8	4	3	9	4	4	PCS

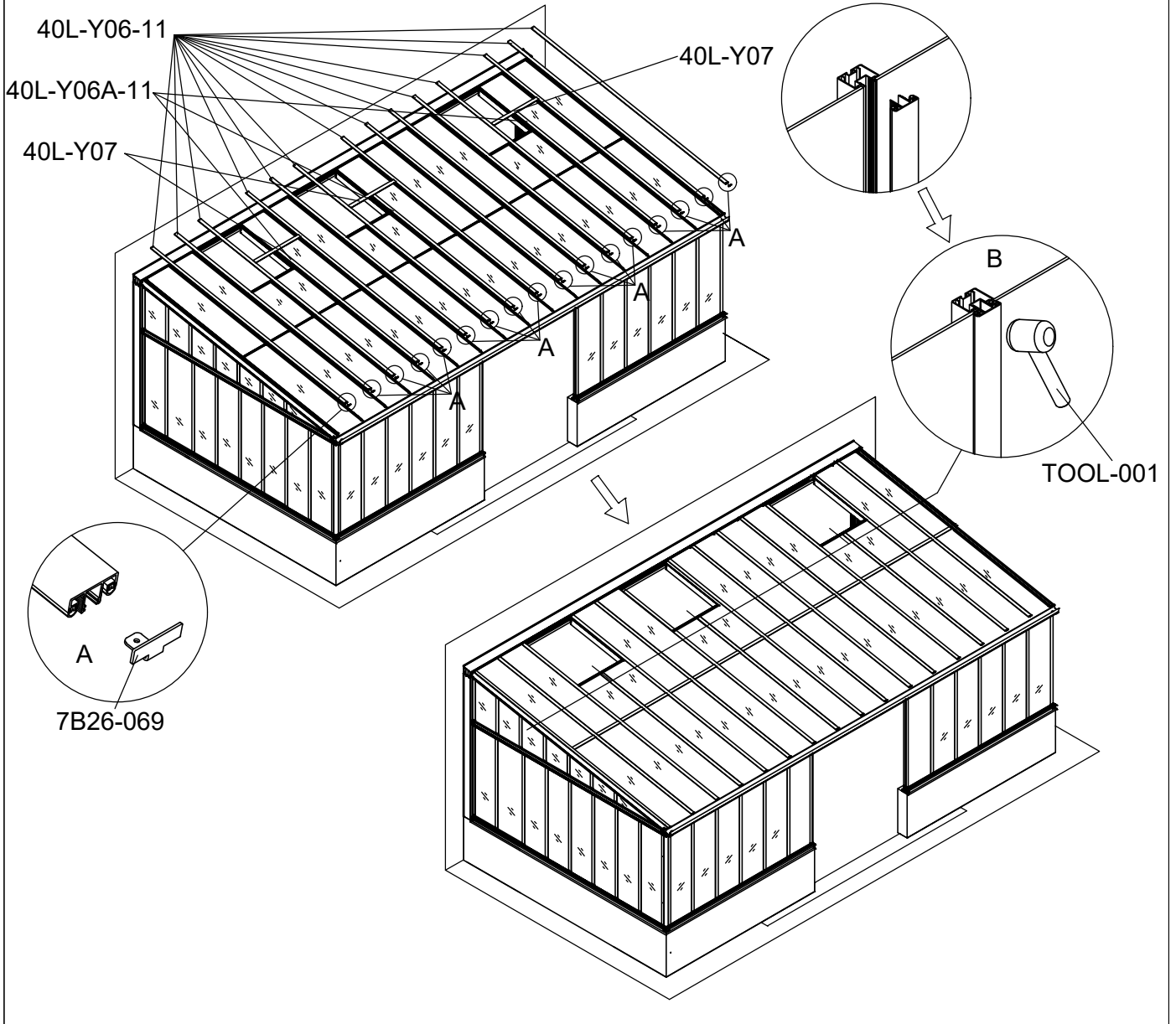

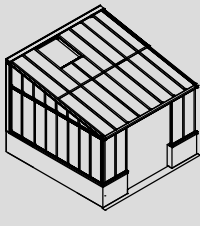
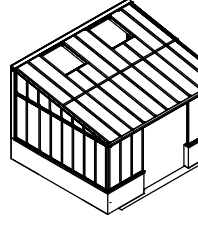
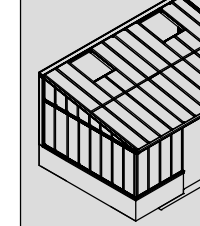
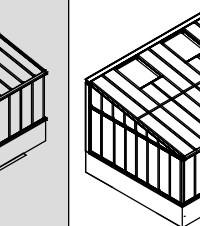
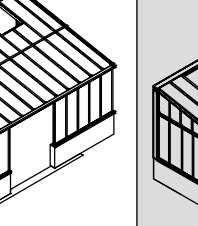
3281	3282	3283	3284	3285
				

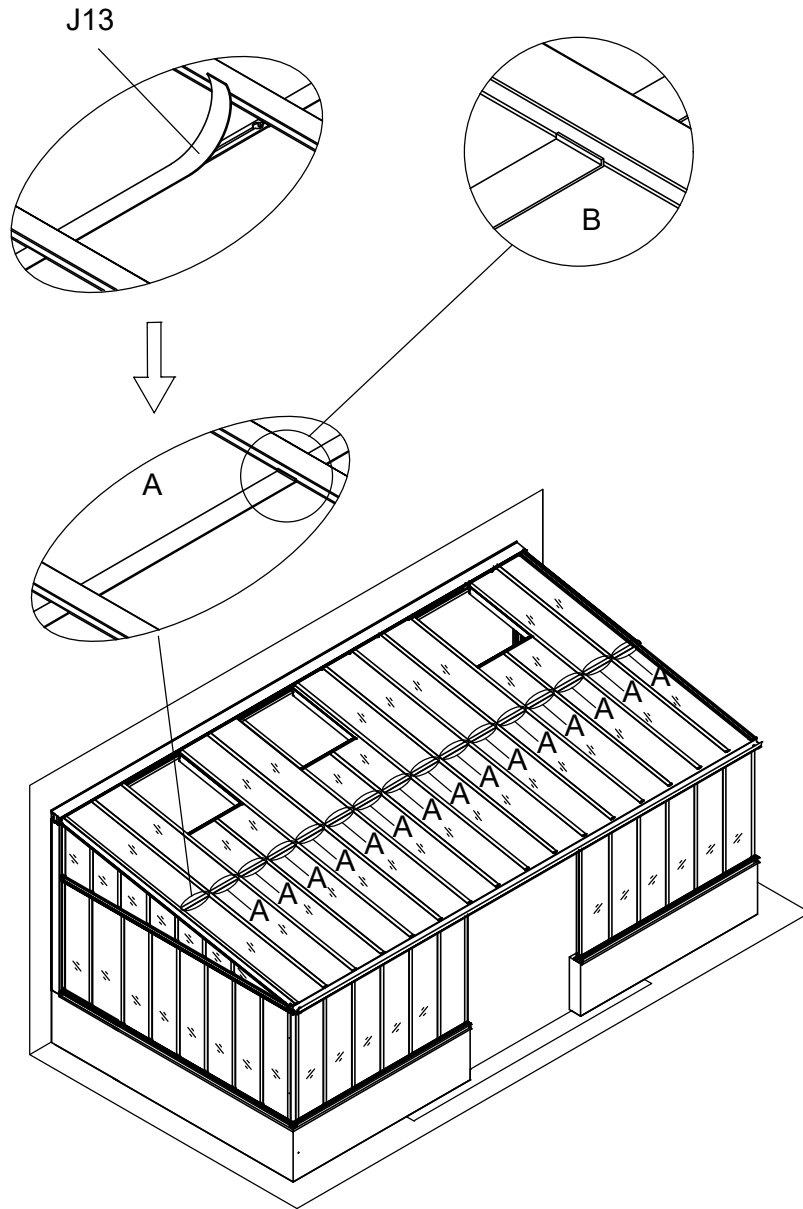

15b/30

Part	NO.	QTY.					Length(MM)
		3281	3282	3283	3284	3285	
	J13	3M	3.8M	4.5M	5.3M	6M	

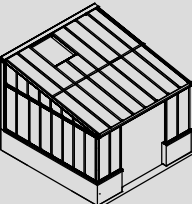
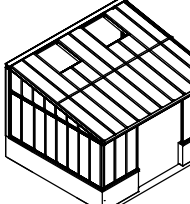
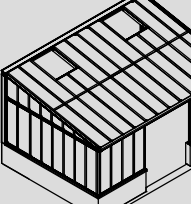
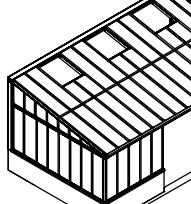
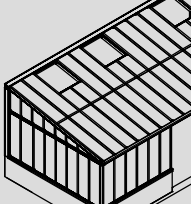

3281	3282	3283	3284	3285
				

15c/30

Part	NO.	QTY.															Length (MM)
		3281			3282			3283			3284			3285			
		3281	3281P-S-1	3281P-S-2	3282	3281P-S-1	3281P-S-2	3283	3281P-S-1	3281P-S-2	3284	3281P-S-1	3281P-S-2	3285	3281P-S-1	3281P-S-2	
	40L-Y08N3	0	2	0	0	2	0	0	2	0	0	2	0	0	2	0	335
	40L-Y08N4	0	6	0	0	6	2	0	6	4	0	6	6	0	6	8	337
	Z4.8-19	16	8	0	20	8	2	24	8	4	28	8	6	32	8	8	PCS

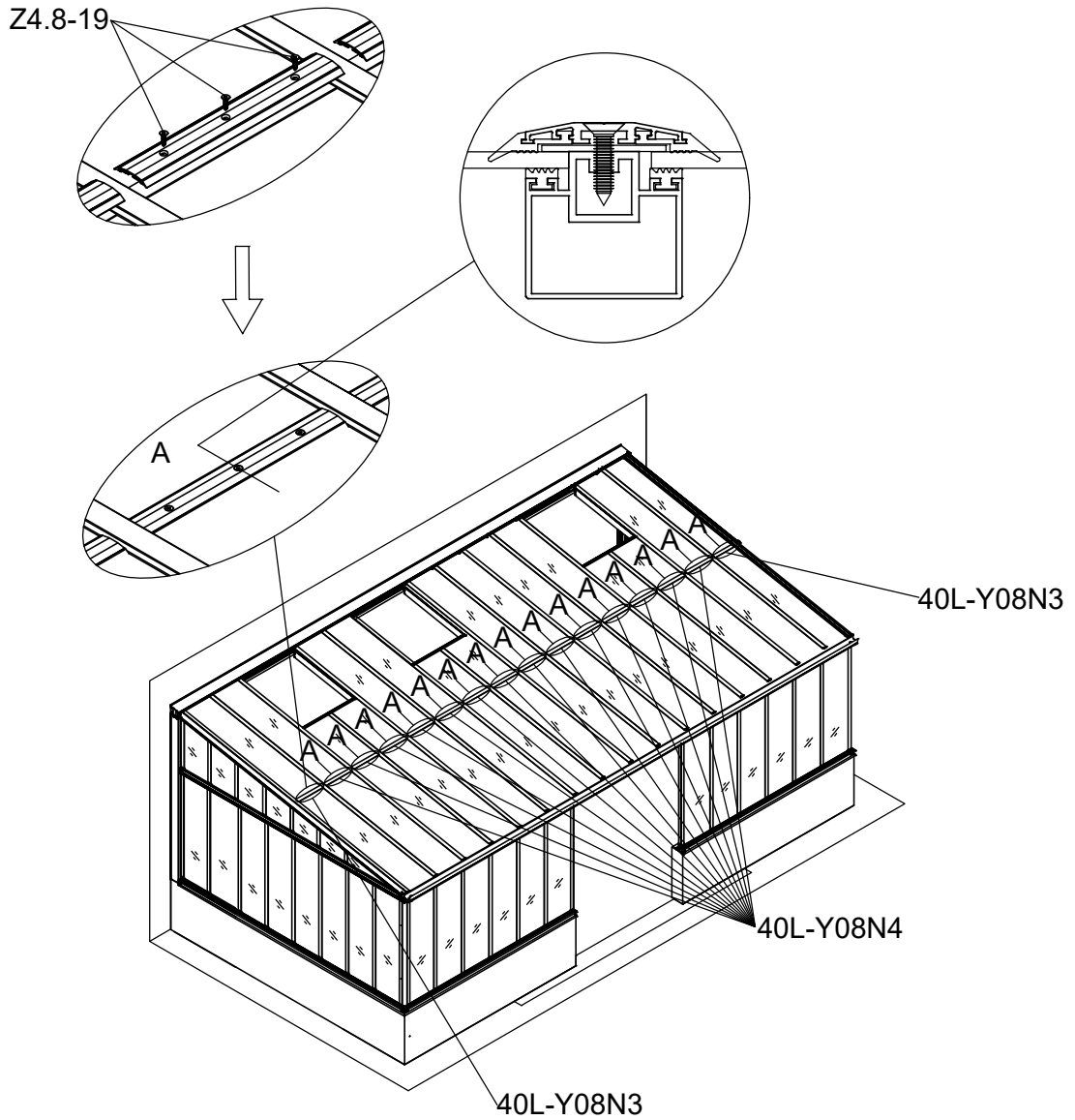

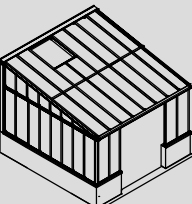
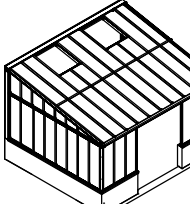
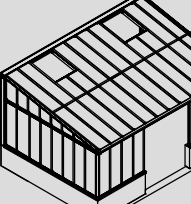
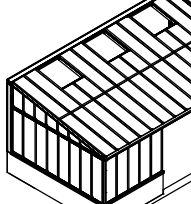
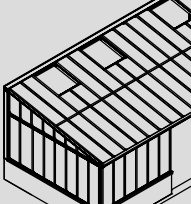

3281	3282	3283	3284	3285
				

15d/30

Part	NO.	QTY.					Length(MM)
		3281	3282	3283	3284	3285	
	7C26-038	3M	3M	3.8M	3.8M	4.5M	

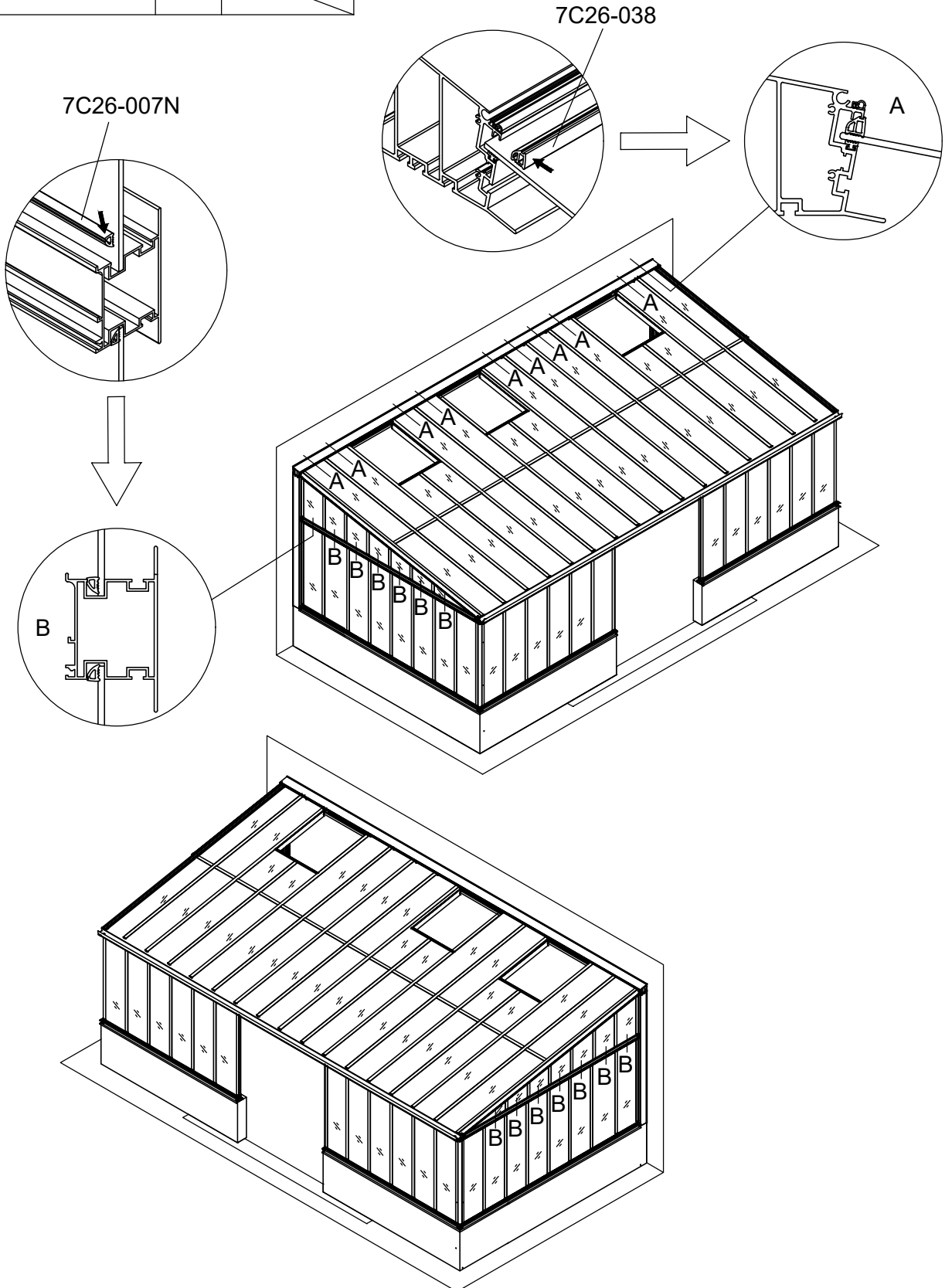

Part	NO.	QTY.	Length(MM)
	7C26-007N	6.5M	



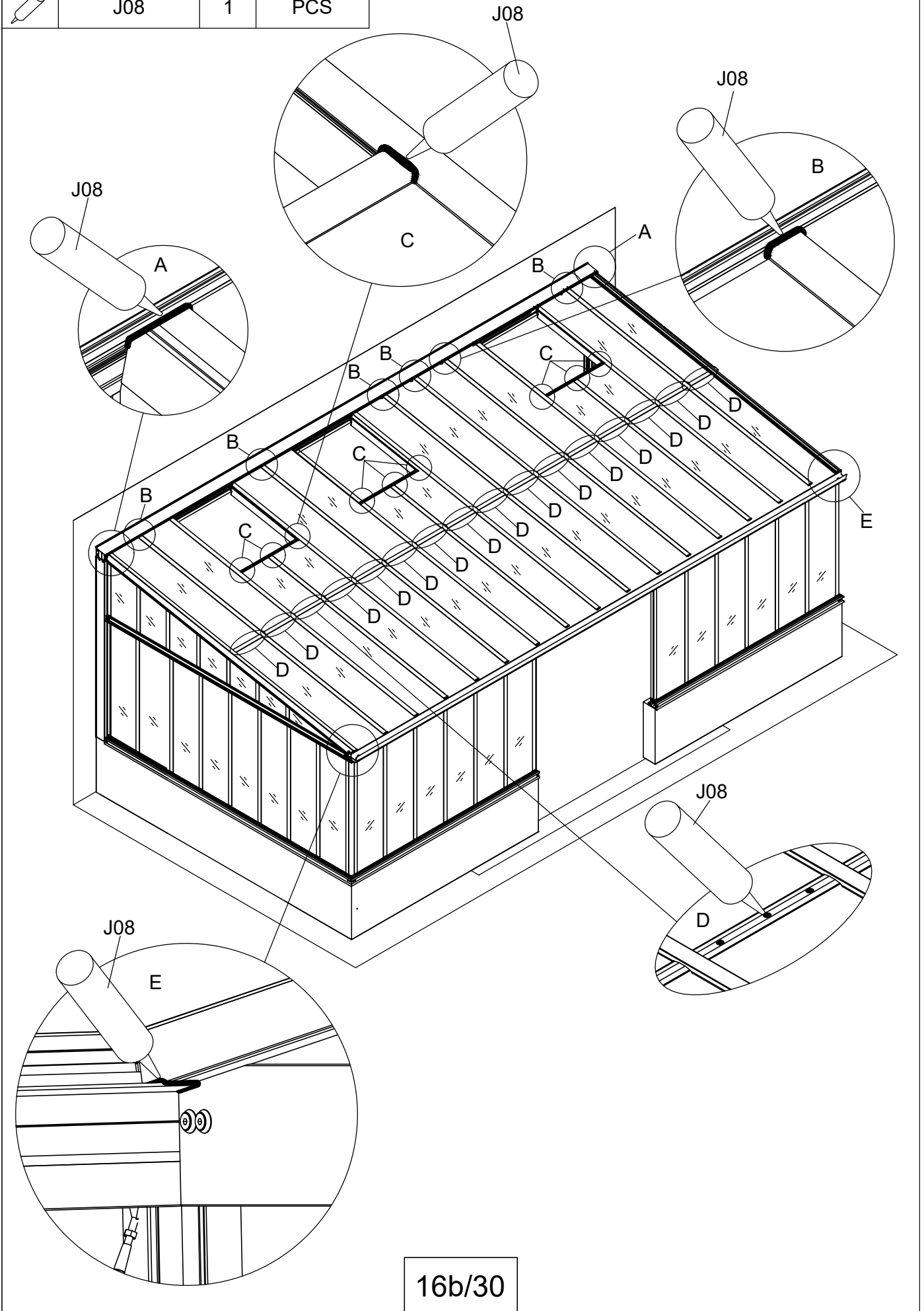





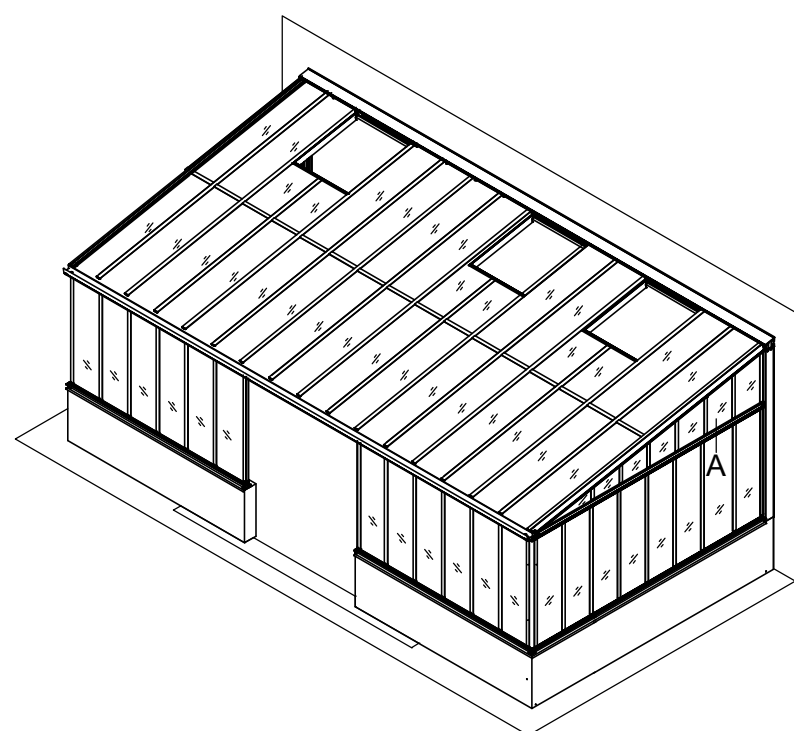
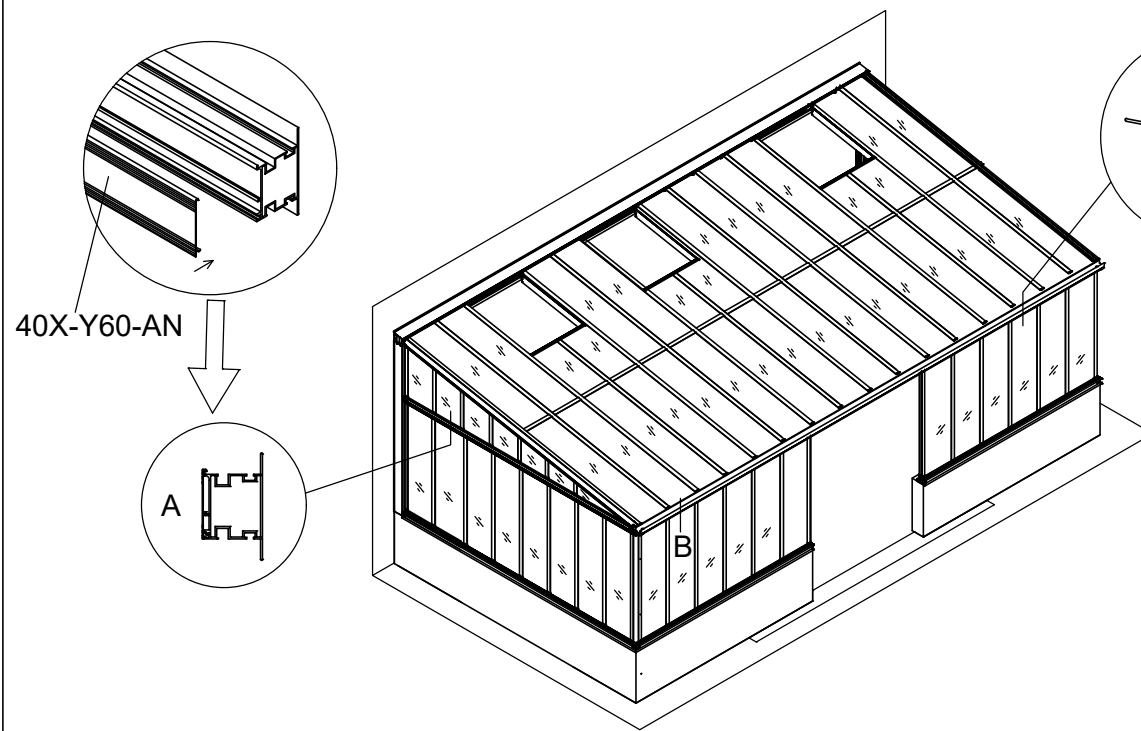
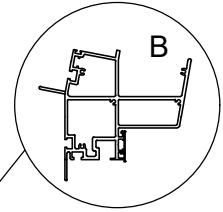
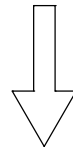
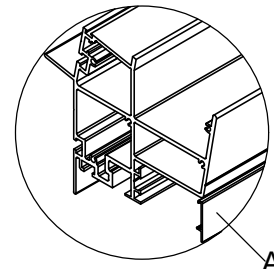

Part	NO.	QTY.	Length(MM)
	J08	1	PCS



Part	Product	NO.	Length(MM)	QTY.	CTN NO.	Code
	3282	40L-Y62A-5B	431	2	3171P-S-5D	A015
	3283	40L-Y62A-6B	807	2	3171P-S-6D	
	3284	40L-Y62A-7B	1182	2	3171P-S-7D	
	3285	40L-Y62A-8B	1558	2	3171P-S-7D	

Part	NO.	Length(MM)	QTY.	CTN NO.
	40X-Y60-AN	3023	1	3171P-S-BASE4R
	40X-Y60-AN	3023	1	3171P-S-4F



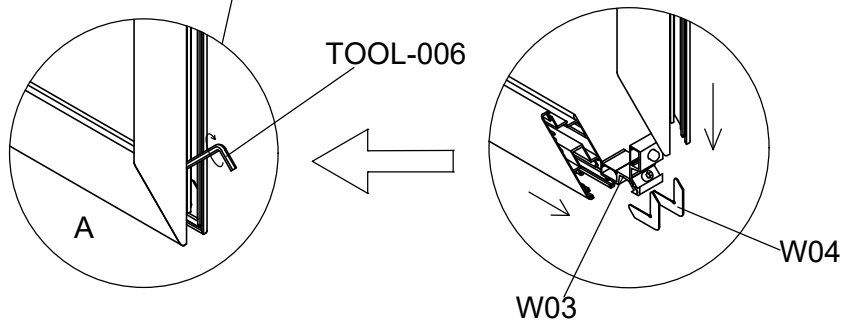
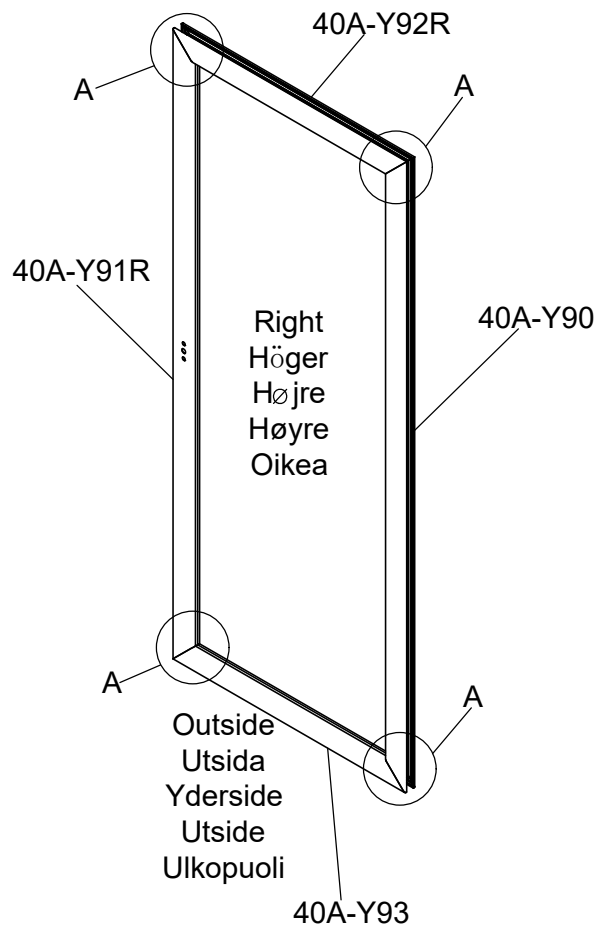
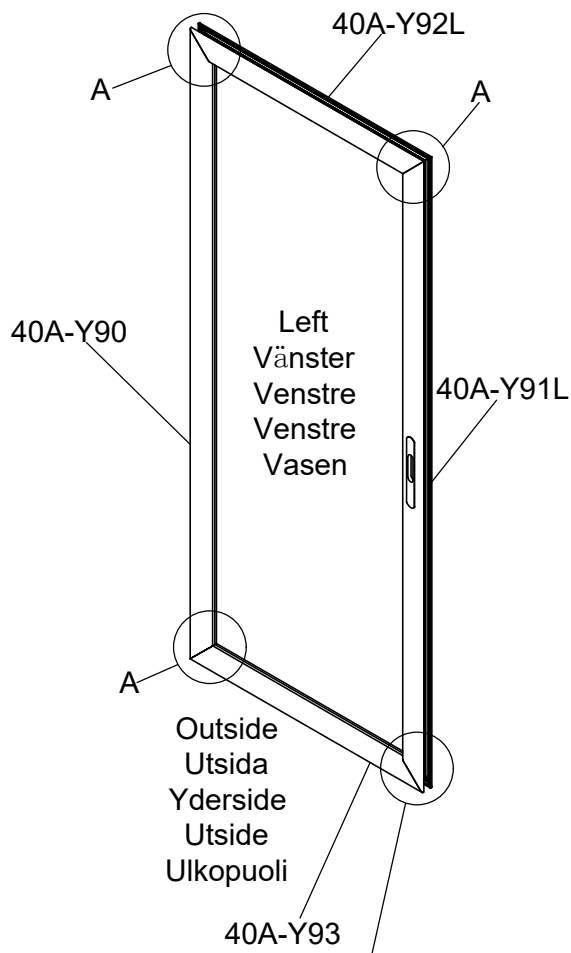

Part	NO.	QTY.	Length(MM)
	40A-Y90	2	1866
	40A-Y91R	1	1866
	40A-Y91L	1	1866
	40A-Y92R	1	769
	40A-Y92L	1	769
	40A-Y93	2	769
	W03	8	30
	W04	16	PCS

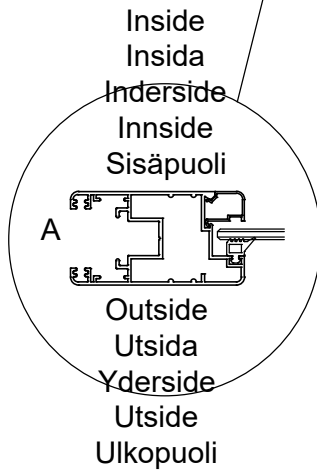
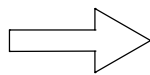
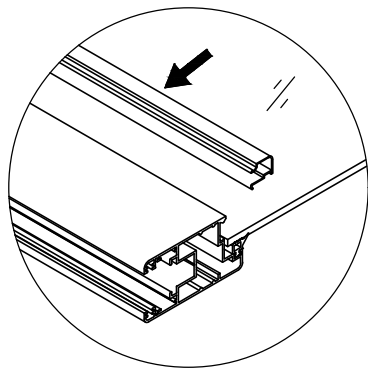
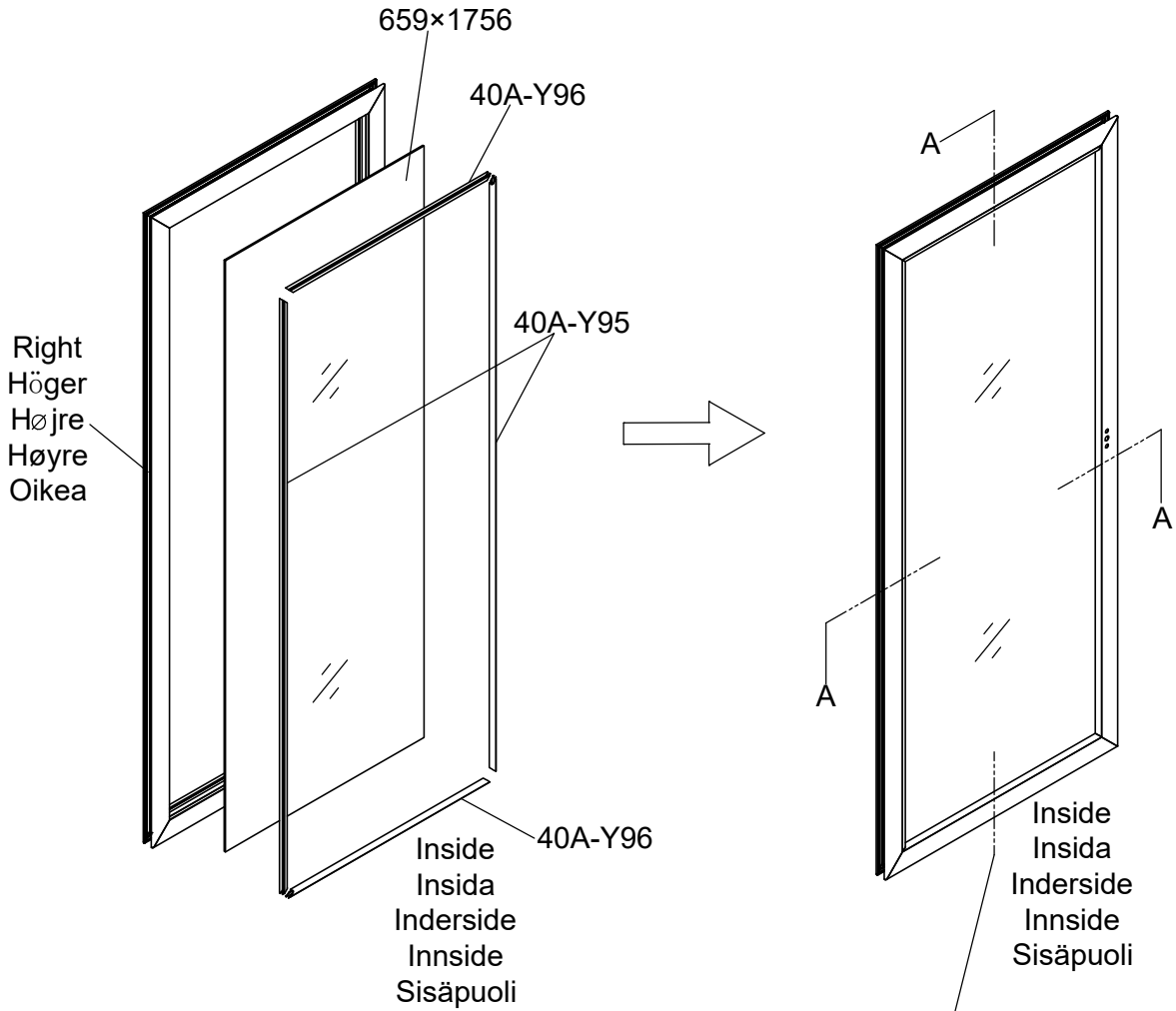

Part	NO.	QTY.	Length(MM)
	659×1756	1	1756
	40A-Y95	2	1765
	40A-Y96	2	668



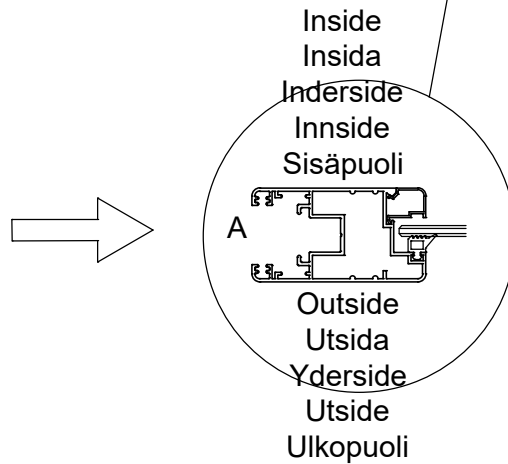
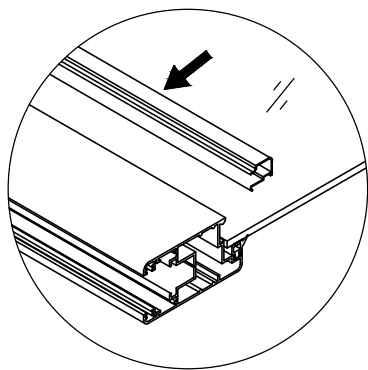
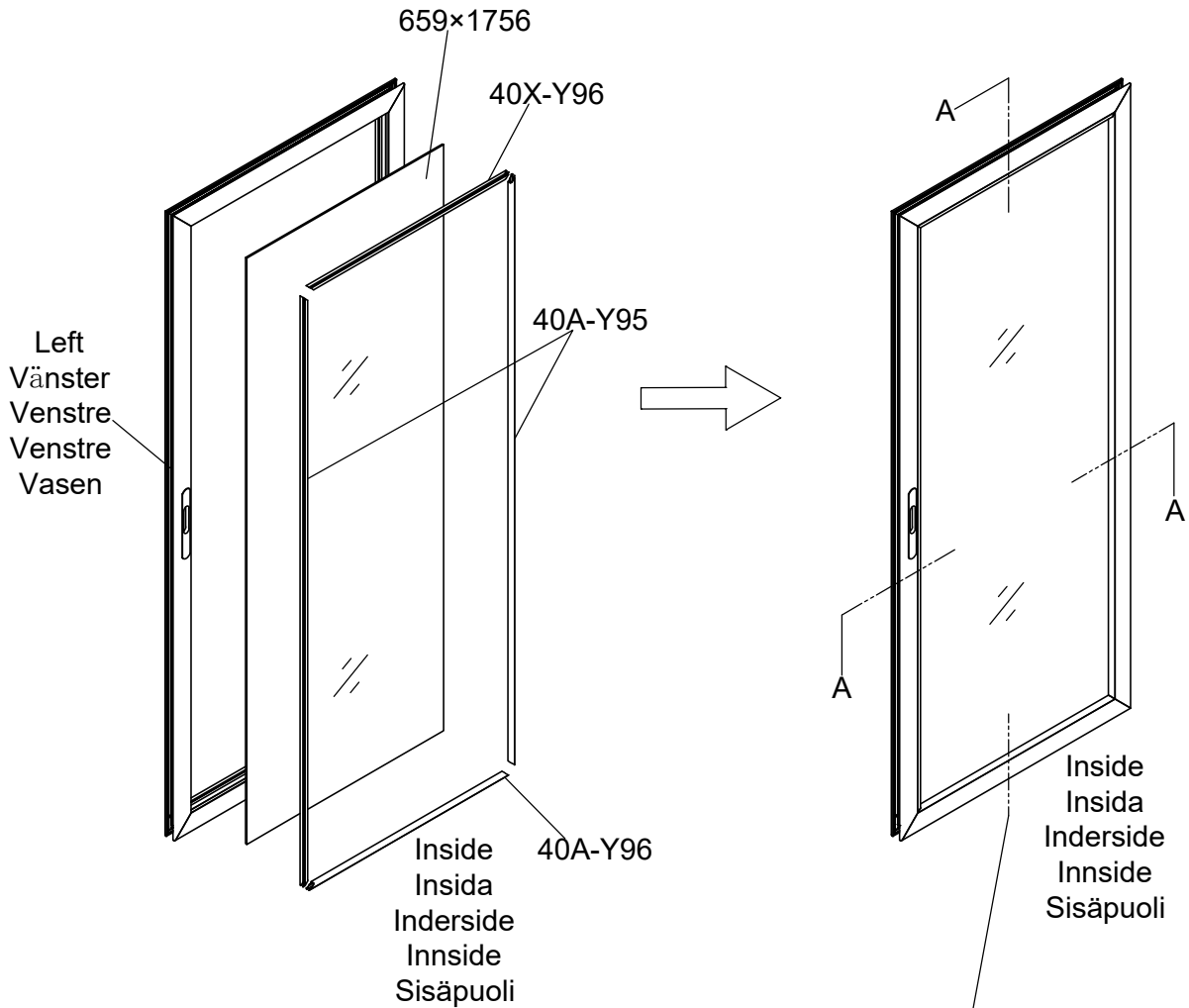

Part	NO.	QTY.	Length(MM)
	659×1756	1	1756
	40A-Y95	2	1765
	40A-Y96	2	668



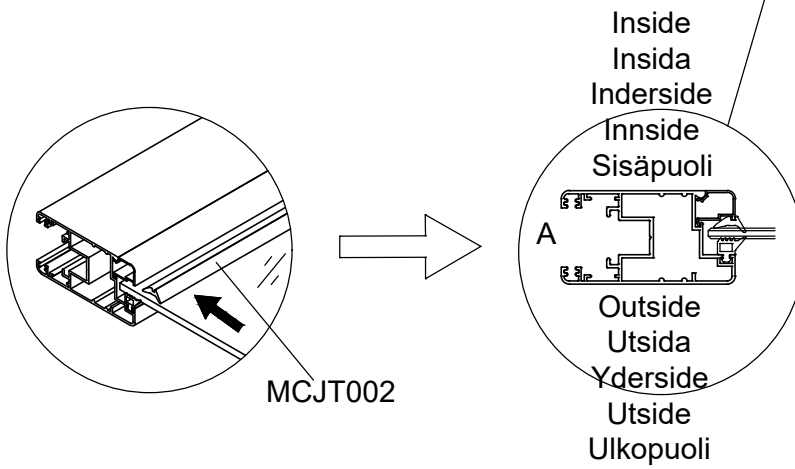
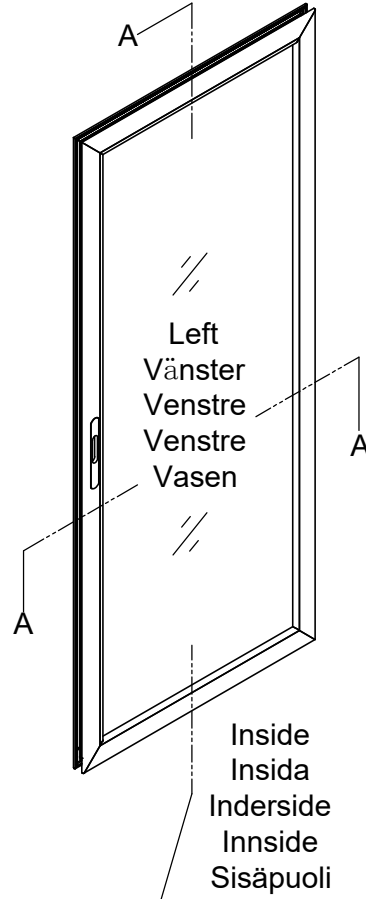
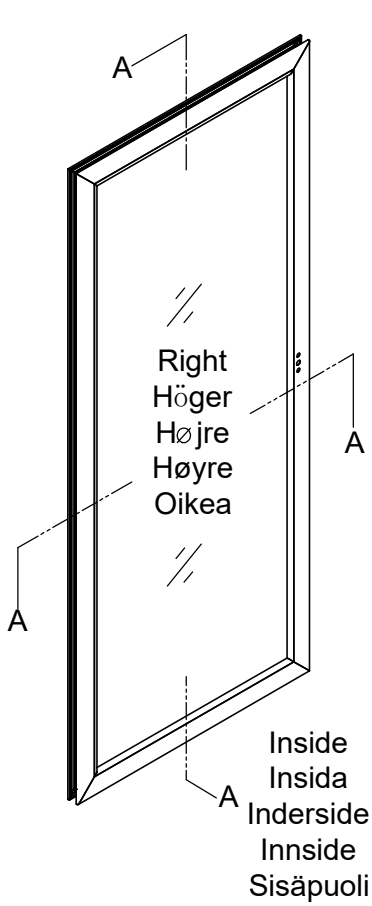

Part	NO.	QTY.	Length(MM)
	MCJT002	11M	



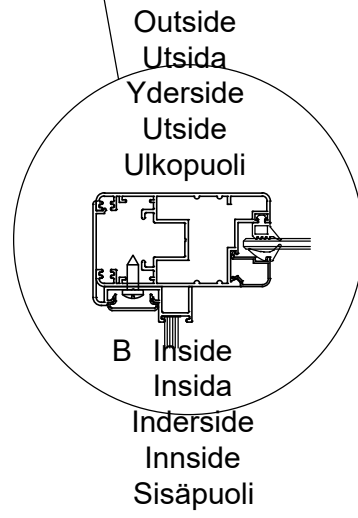
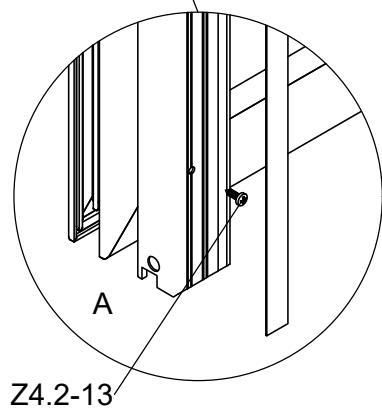
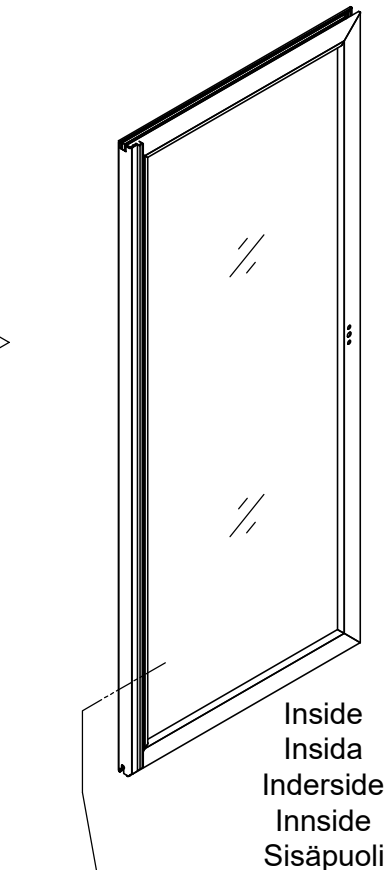
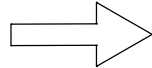
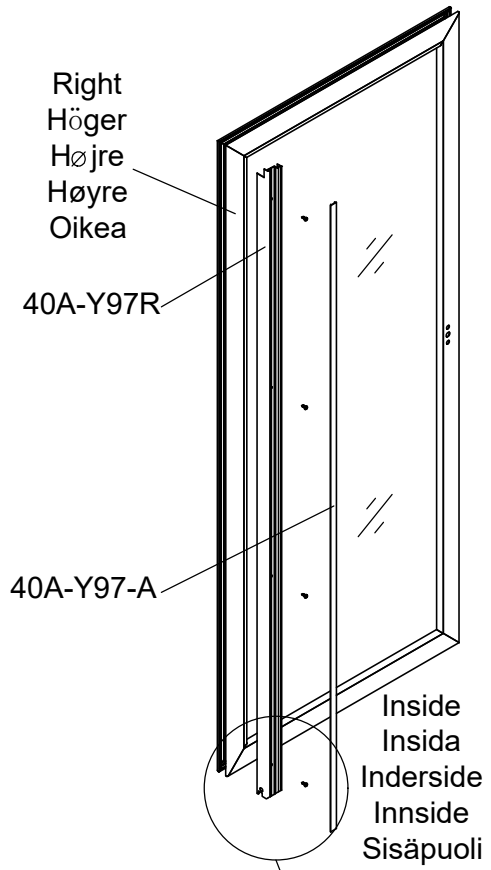



Part	NO.	QTY.	Length(MM)
	40A-Y97R	1	1860
	40A-Y97-A	1	1851
	Z4.2-13	4	PCS

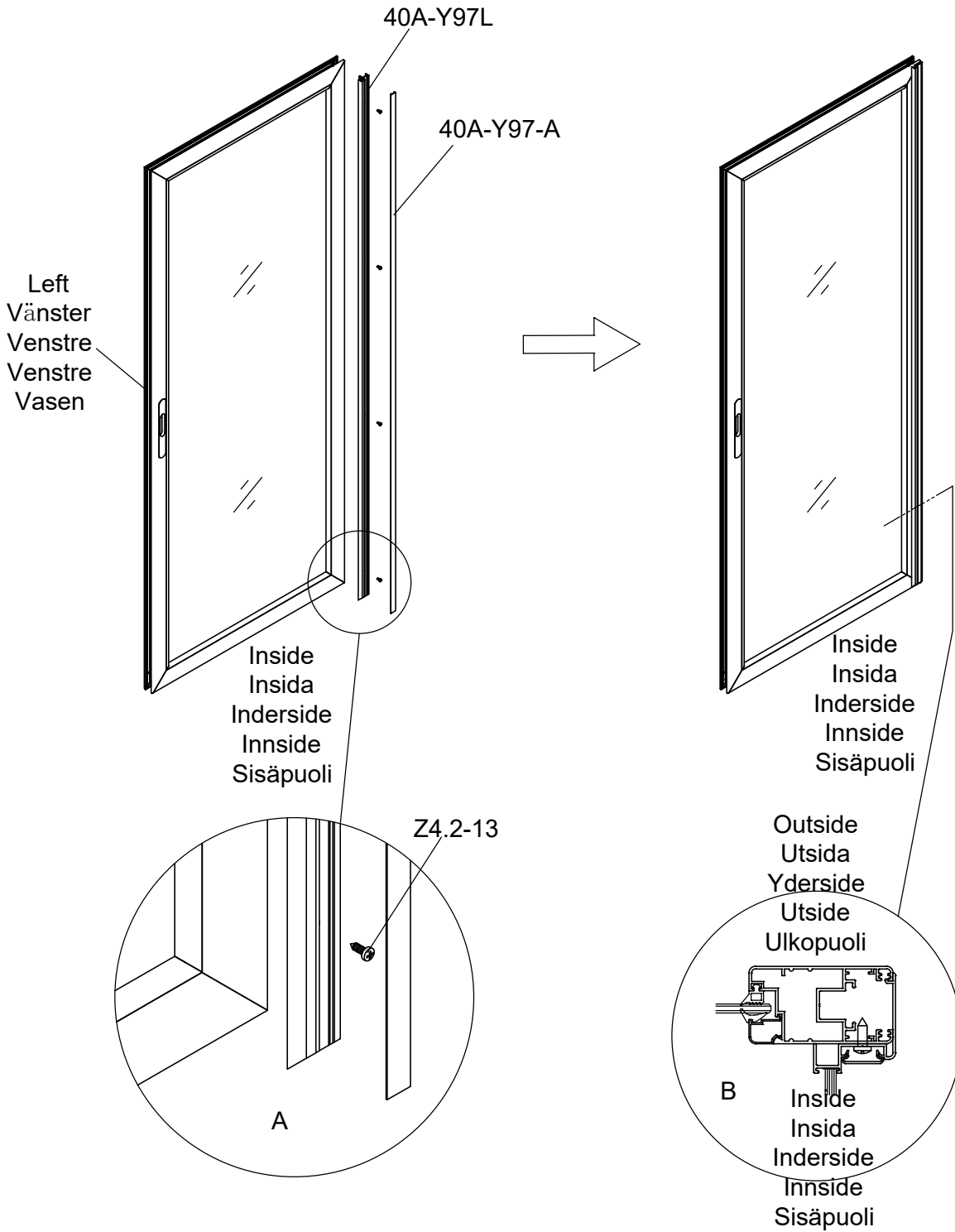

Part	NO.	QTY.	Length(MM)
	40A-Y97L	1	1860
	40A-Y97-A	1	1851
	Z4.2-13	4	PCS



Part	NO.	QTY.	Length(MM)
	40A-Y94	2	1835
	NSST120	3.8M	
	T04	4	PCS
	Z4.2-38	6	PCS
	Z3.5-25	8	PCS

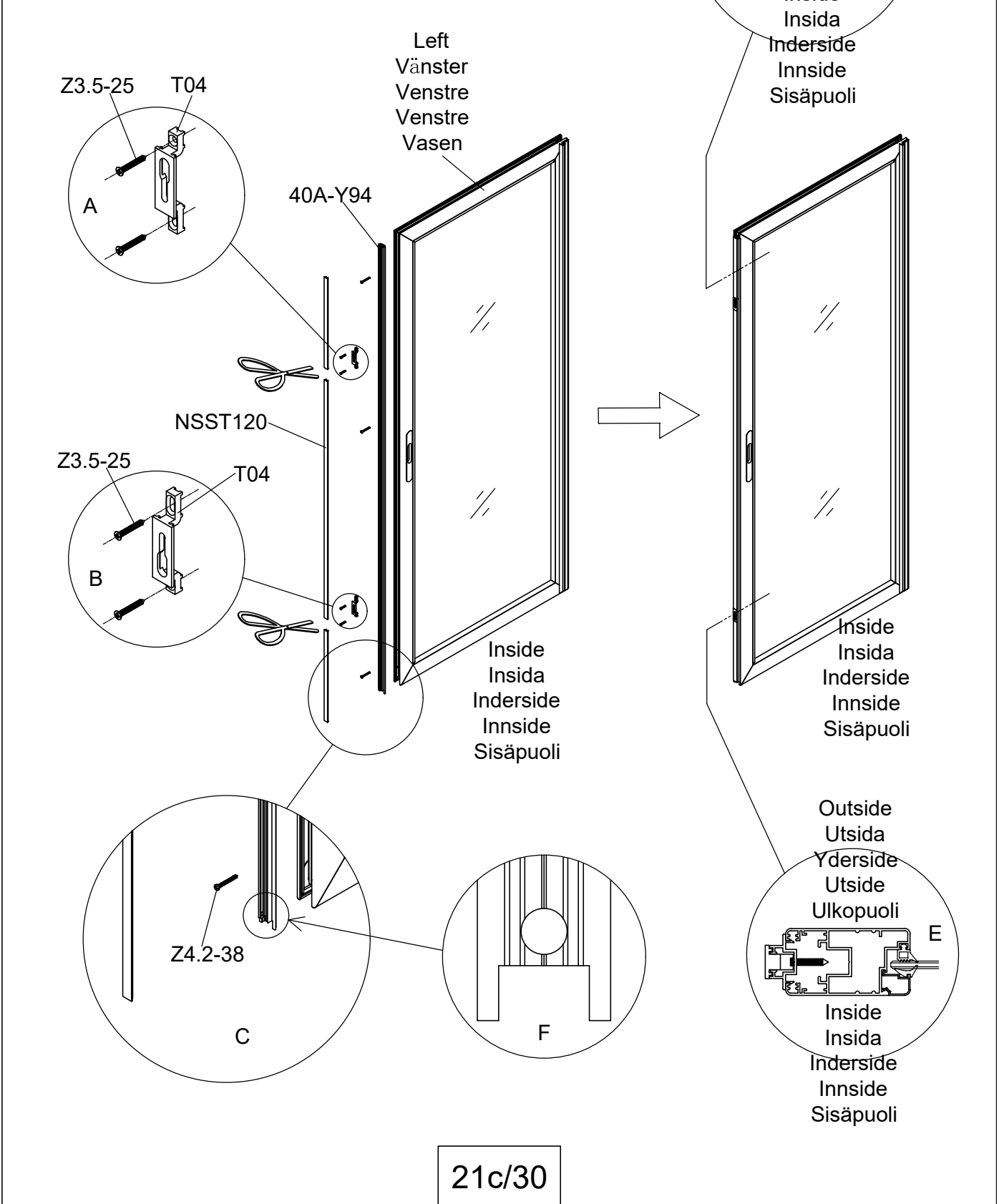

Part	NO.	QTY.	Length(MM)
	40A-Y98-R	1	1910
	40A-Y98-L	1	1910
	M6-35	2	PCS
	Si6-35	6	PCS
	J05	6	PCS

Code	Length(MM)				
		3181	3182	3183	3184
L3	44.5	420	795.5	1171	1546.5

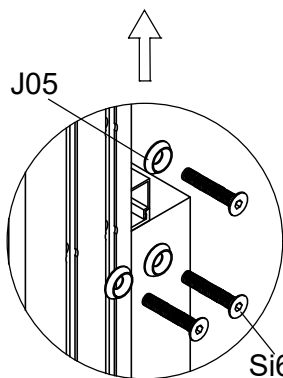
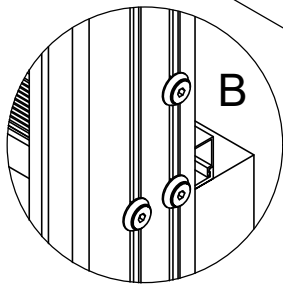
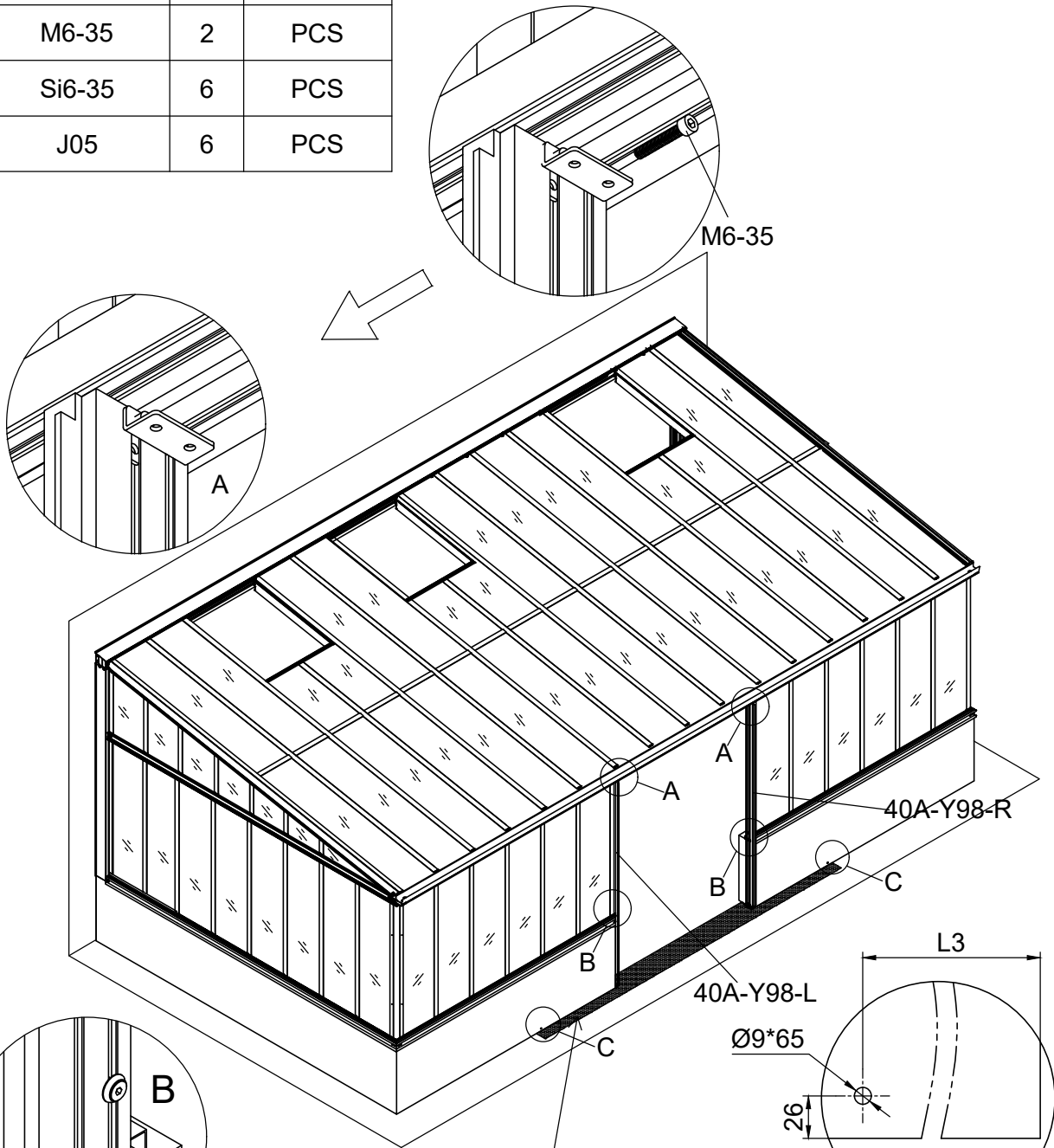





Make sure the floor below the doors frame should be flat and solid.

Se till att underlaget under dörrramen är plan och på solid grund.





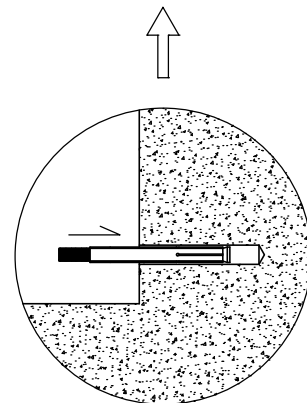
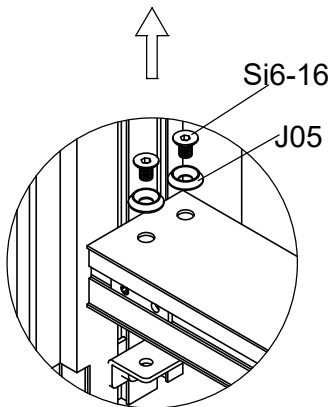
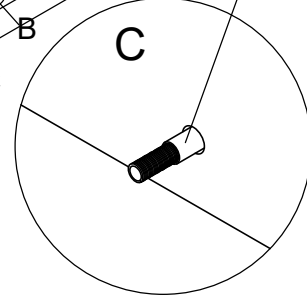
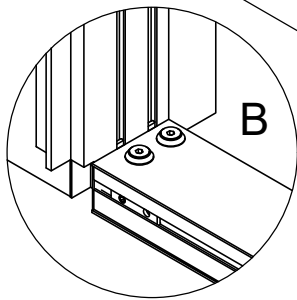
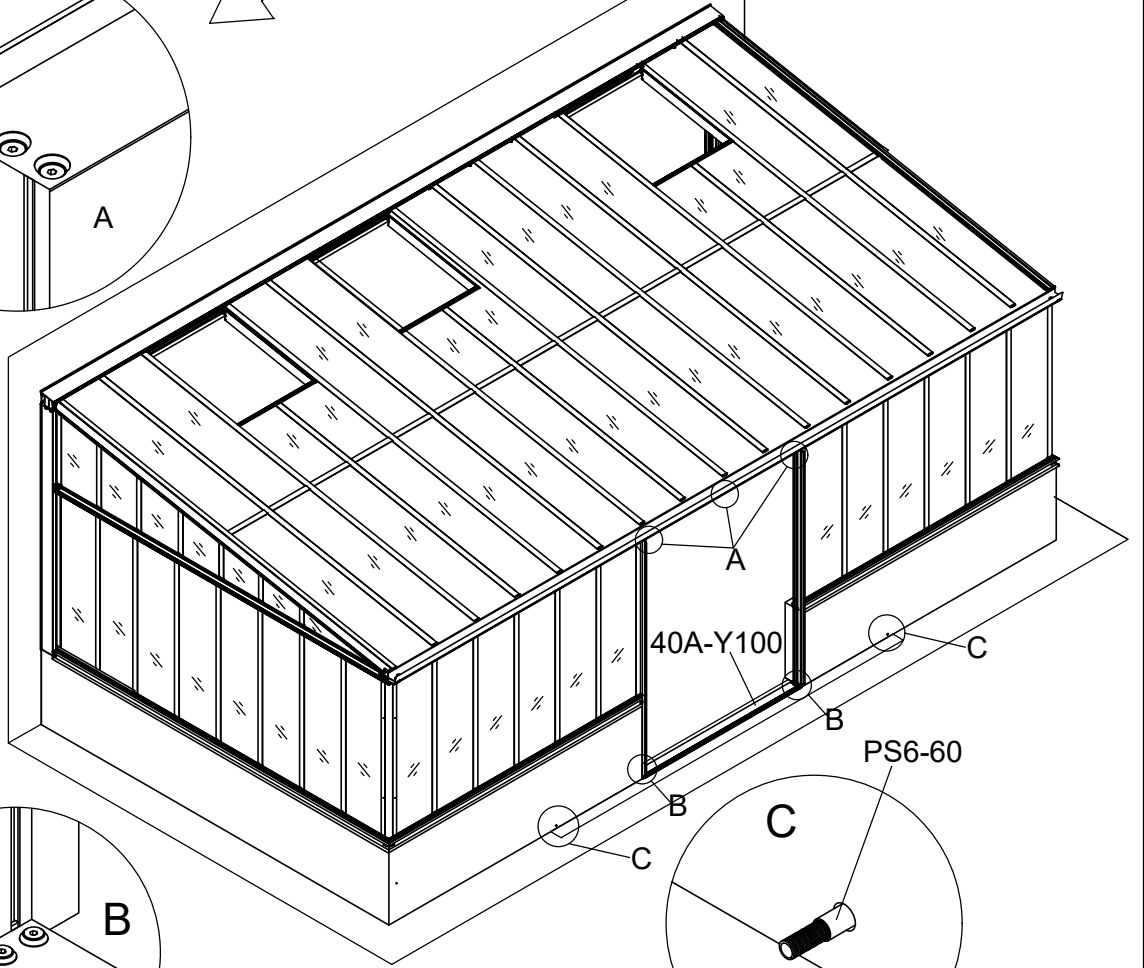
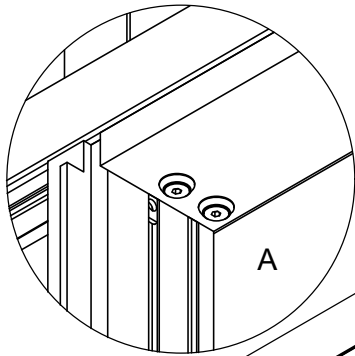
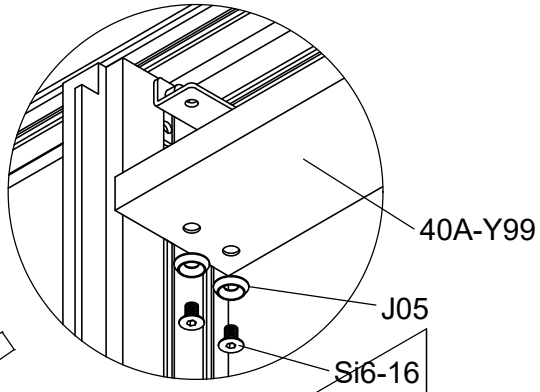

Sørg for, at underlaget under dørkarmen er plan og på fast grund.

Sørg for at underlaget under dørterskelen er slett og på solid fundament.

Tarkista, että maa ovikarmin alla on sileä ja tasainen.



Part	NO.	QTY.	Length(MM)
	40A-Y99	1	1424
	40A-Y100	1	1424
	Si6-16	10	PCS
	J05	10	PCS
	PS6-60	2	PCS

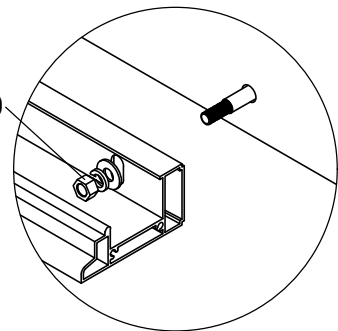
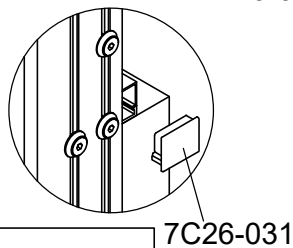
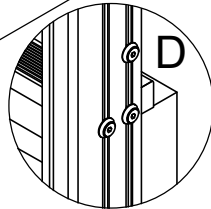
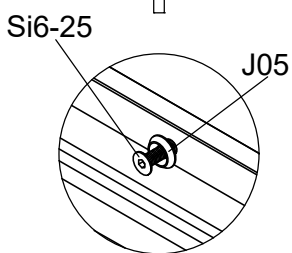
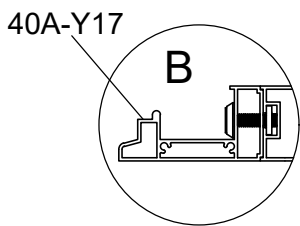
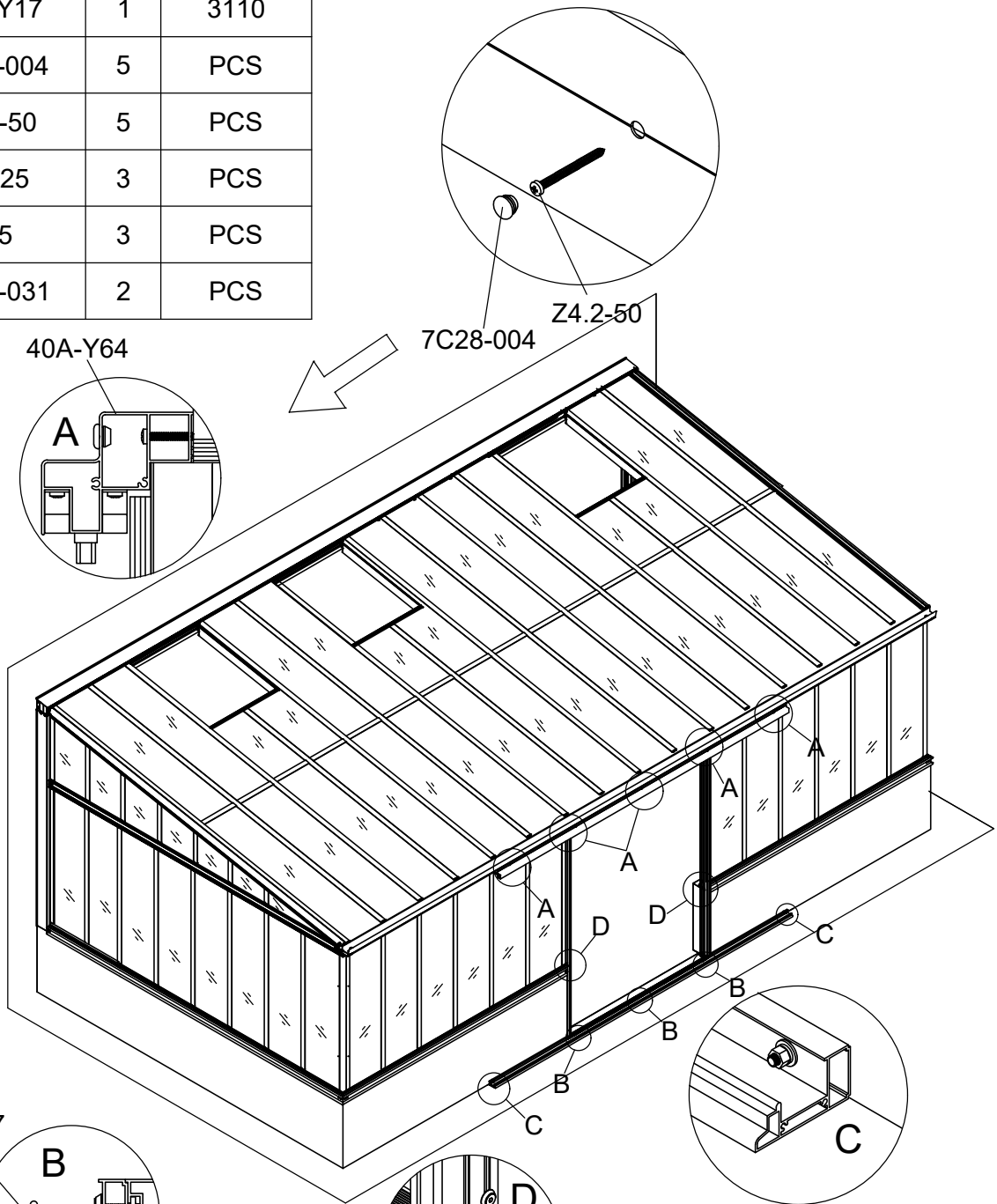

Part	NO.	QTY.	Length(MM)
	40A-Y64	1	3016
	40A-Y17	1	3110
	7C28-004	5	PCS
	Z4.2-50	5	PCS
	Si6-25	3	PCS
	J05	3	PCS
	7C26-031	2	PCS



23a/30

Part	NO.	QTY.	Length(MM)
	40A-Y98A-R	1	1855
	40A-Y98A-L	1	1855

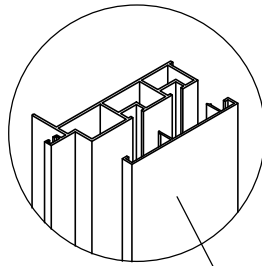
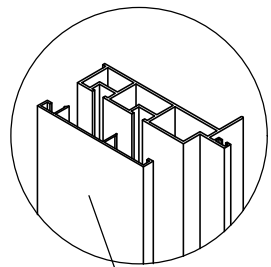
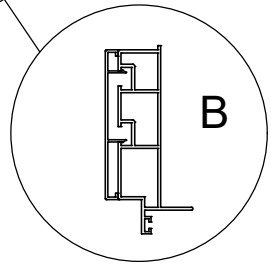
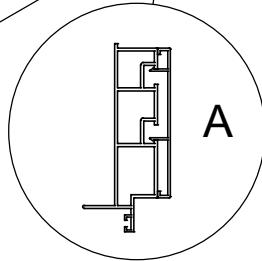
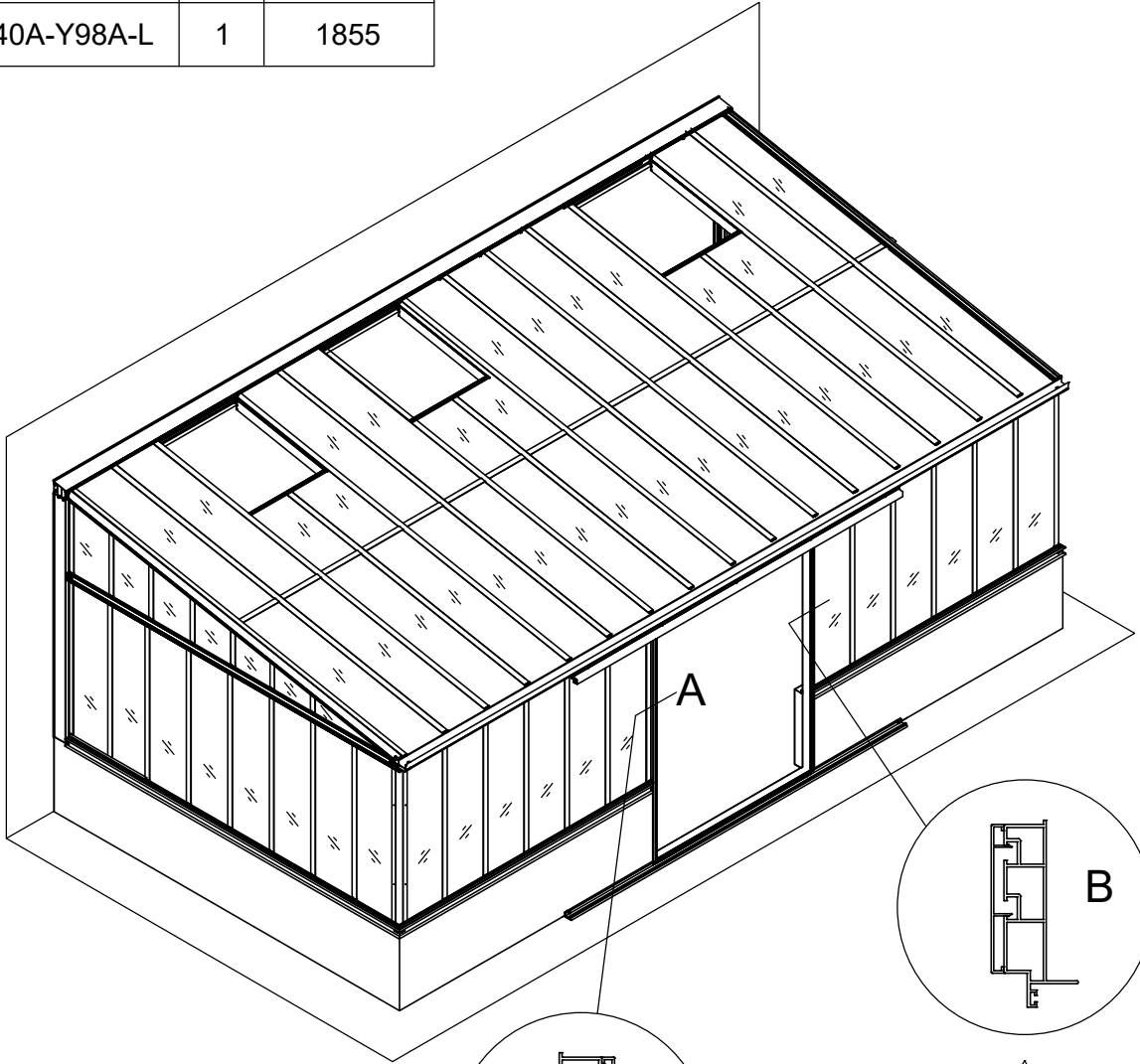

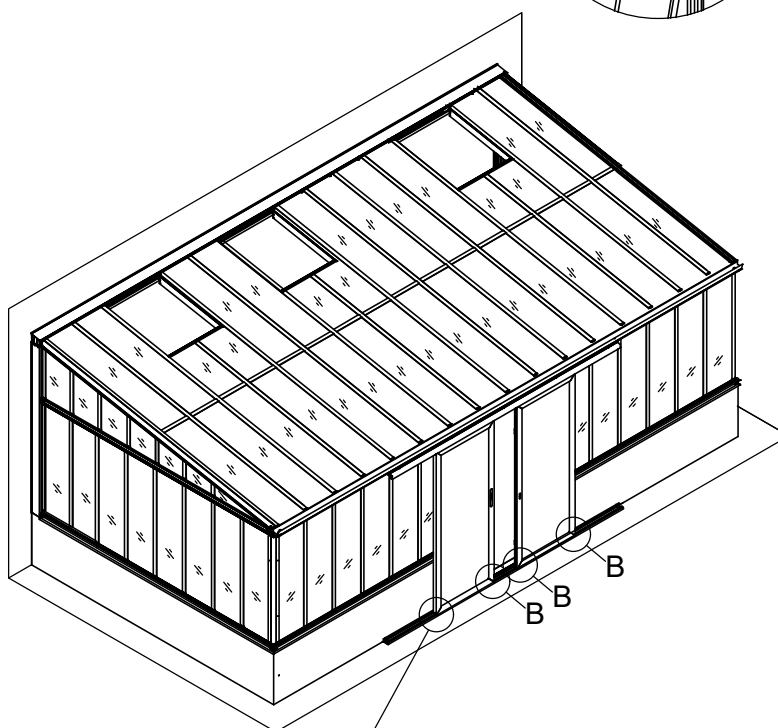
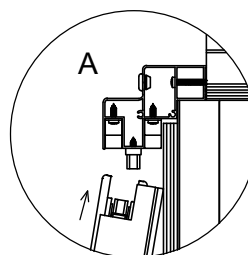
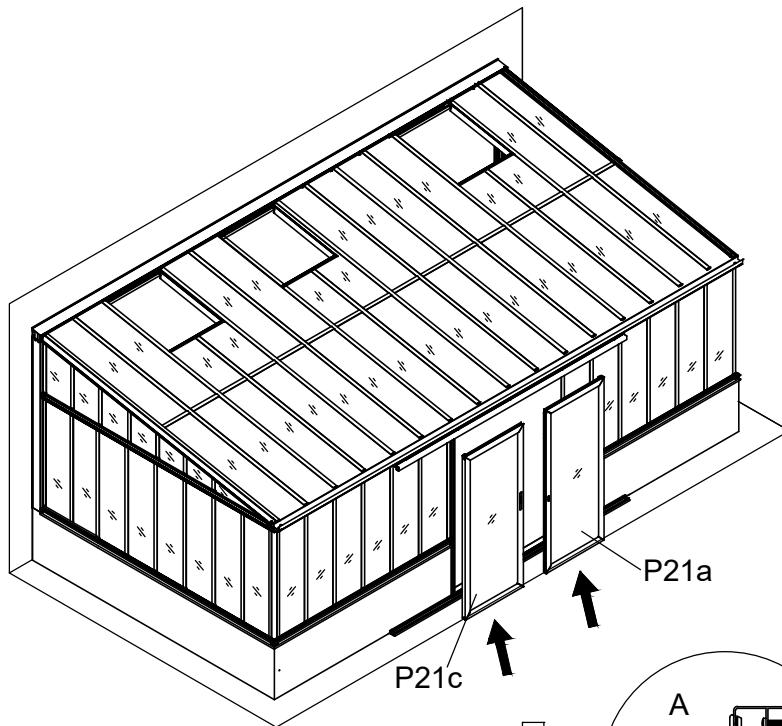



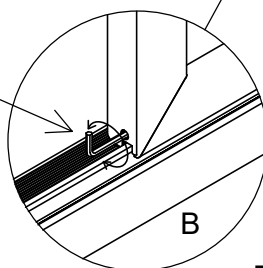



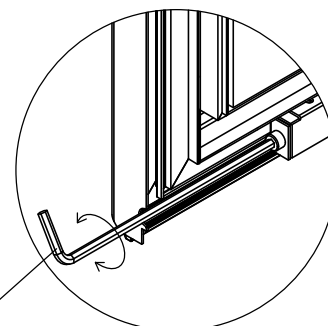



Adjust the height of the wheels
 Justera höjden för hjulen
 Juster højden af hjulene
 Justere høyden for hjulene
 Säädä alapyörien korkeus



TOOL-005







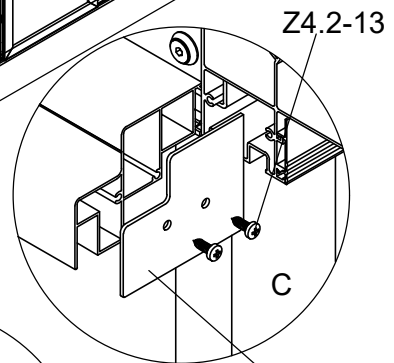
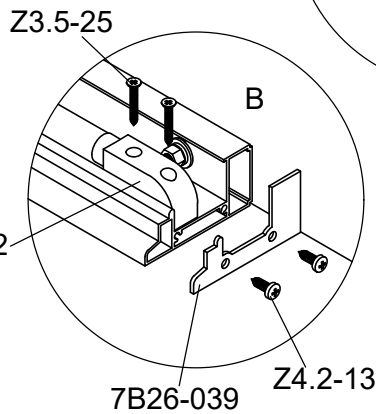
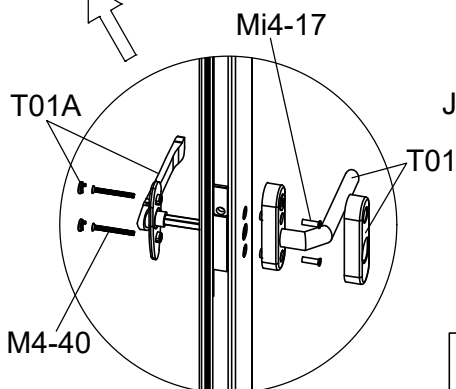
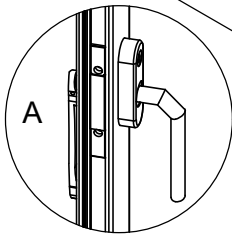
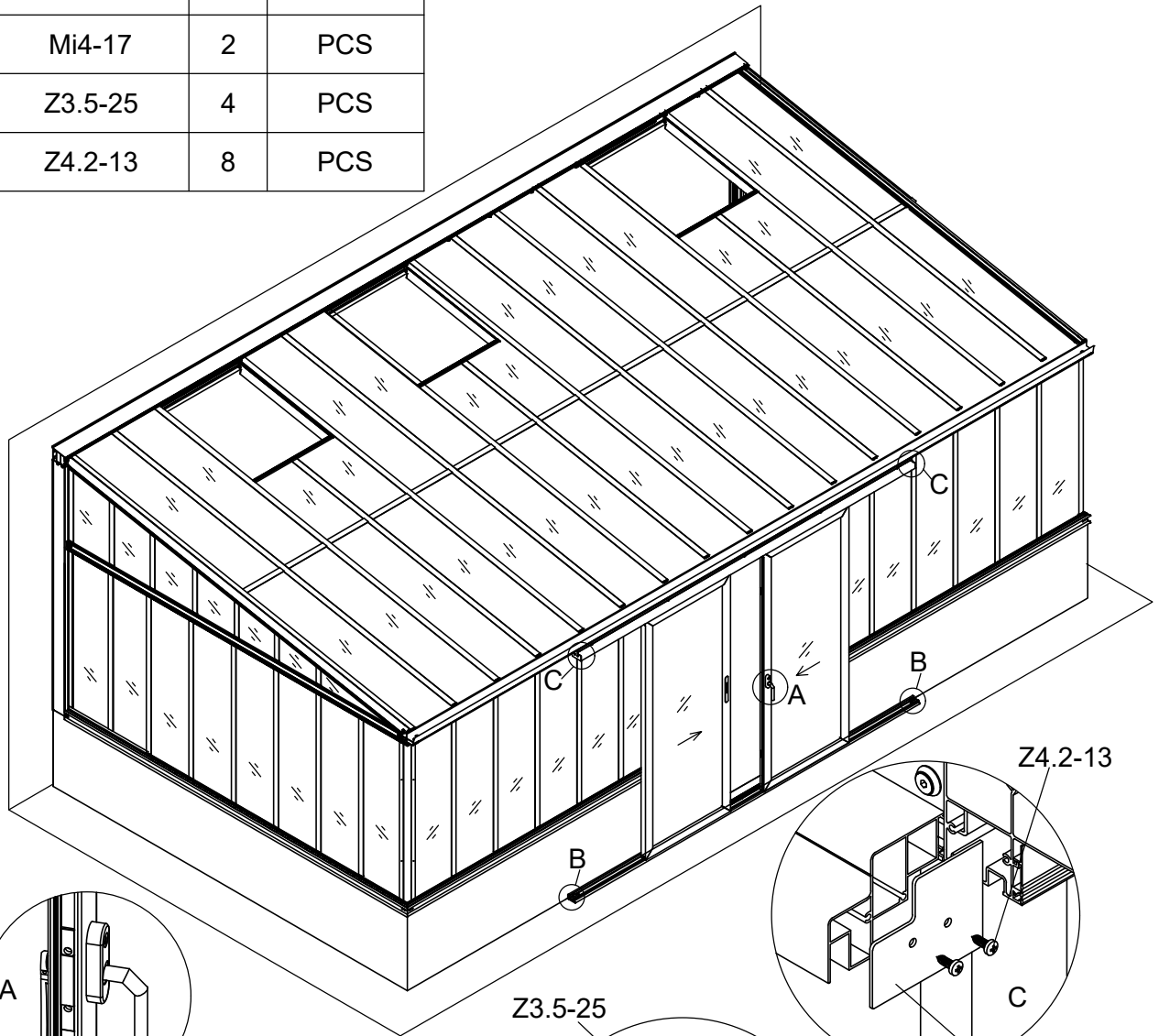



24a/30



Part	NO.	QTY.	Length(MM)
	T01	1	PCS
	T01A	1	PCS
	J02	2	PCS
	7B26-039	2	PCS
	7B26-038	2	PCS
	M4-40	2	PCS
	Mi4-17	2	PCS
	Z3.5-25	4	PCS
	Z4.2-13	8	PCS

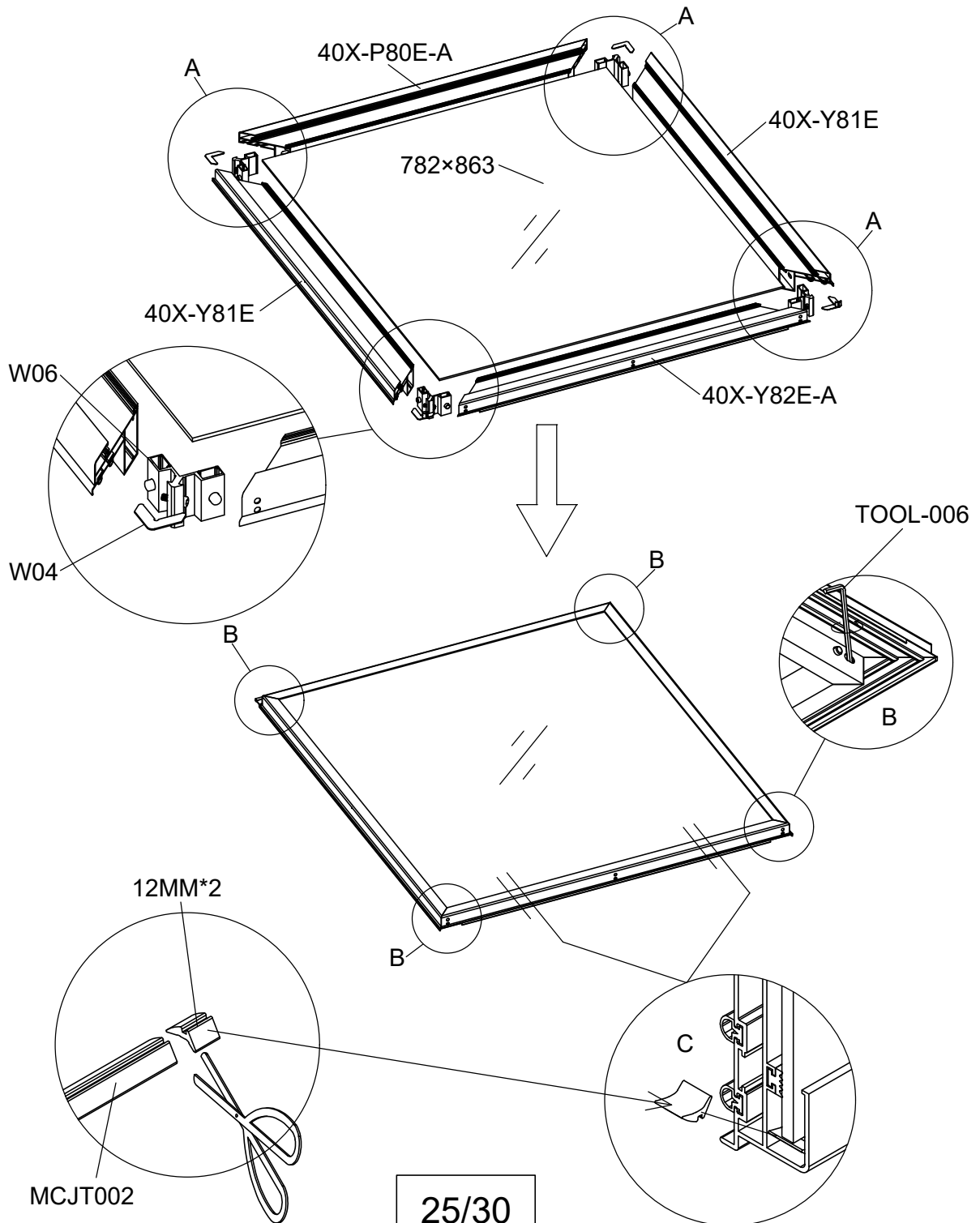

24b/30

Part	NO.	QTY.					Length(MM)	CTN NO.
		3281	3282	3283	3284	3285		
	40X-P80E-A	1	2	2	3	3	791	
	40X-Y81E	2	4	4	6	6	882	
	40X-Y82E-A	1	1	1	1	1	801	3281P-S-1
	40X-Y82E-A	0	1	1	2	2	801	3281P-S-2
	W06	4	8	8	12	12	46	
	W04	4	8	8	12	12	PCS	
	782x863	1	2	2	3	3	863	
	MCJT002	2	4	4	6	6	12	



Part	NO.	QTY.					Length(MM)
		3281	3282	3283	3284	3285	
	MCJT002	3.5M	7M	7M	10.5M	10.5M	
	J09	8	16	16	24	24	PCS

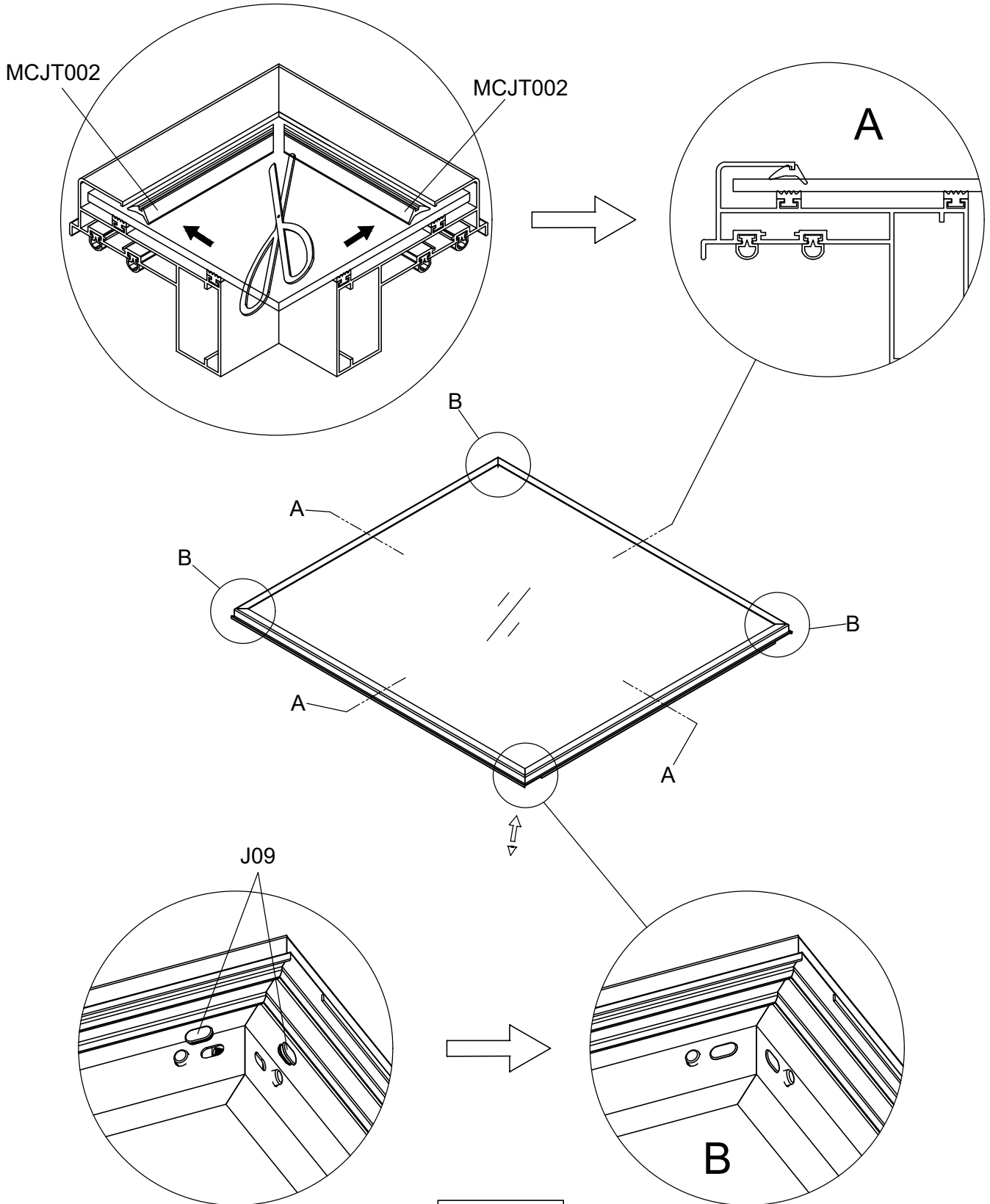

Part	NO.	QTY.					Length(MM)
		3281	3282	3283	3284	3285	
	Si6-12	4	8	8	12	12	PCS
	J05	4	8	8	12	12	PCS

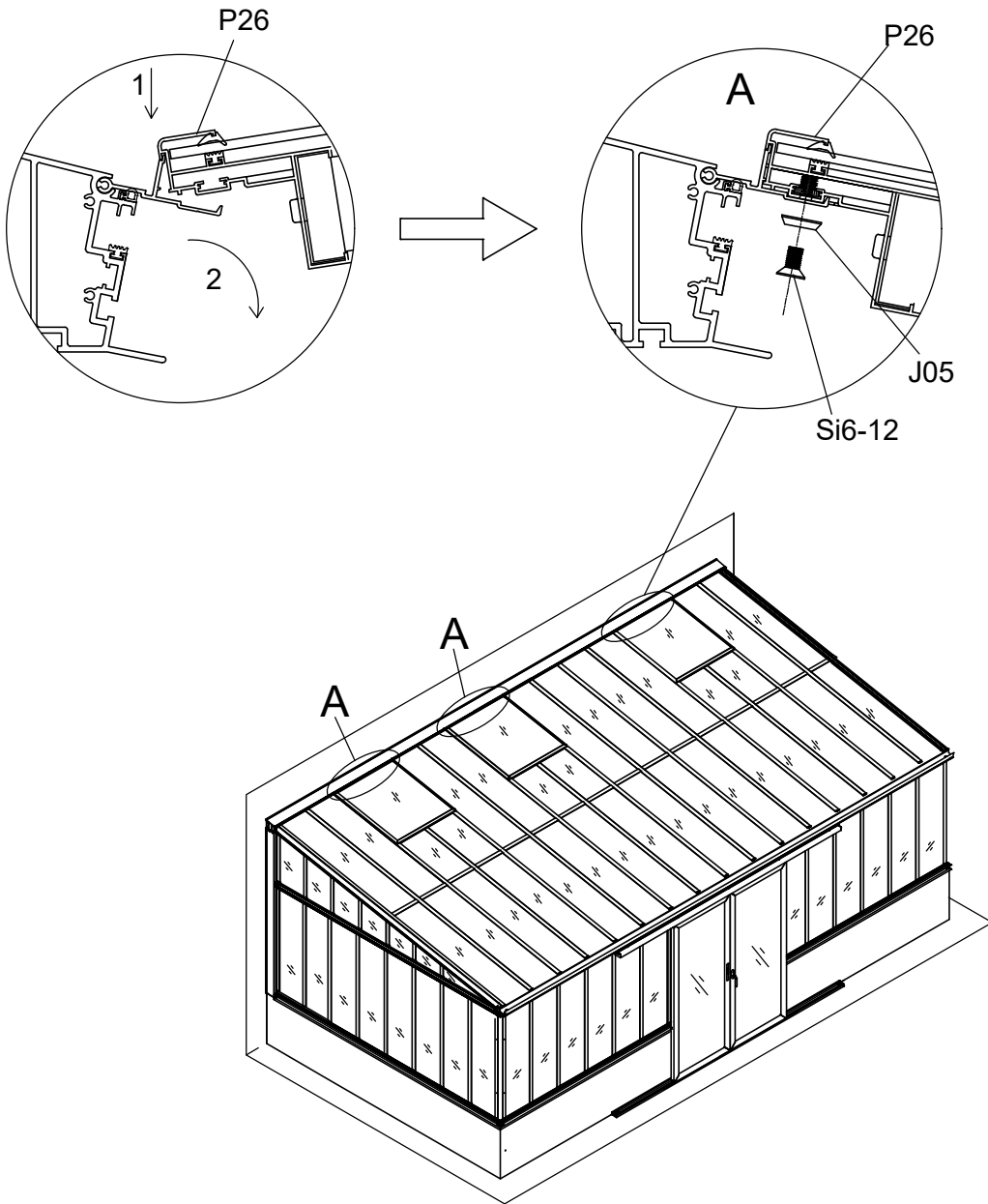

3281	3282	3283	3284	3285

Part	NO.	QTY.	Length(MM)
	J08	1	PCS

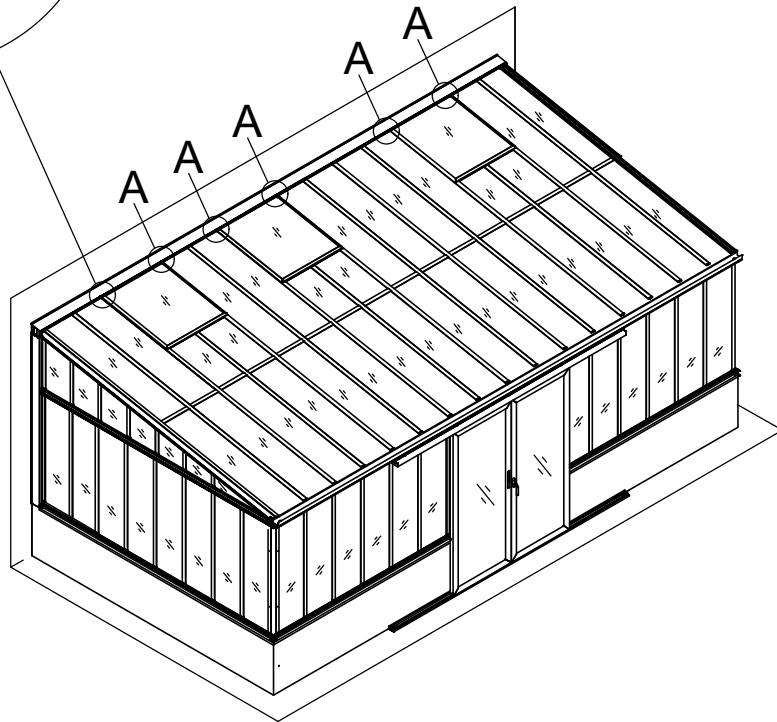
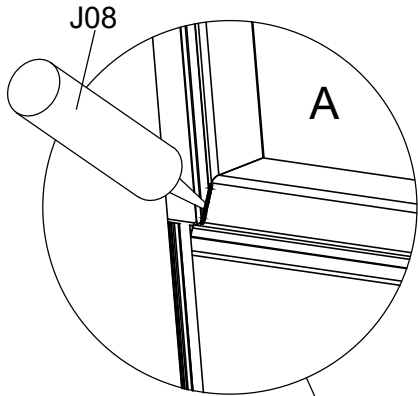

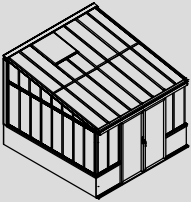
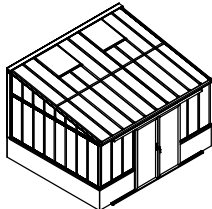
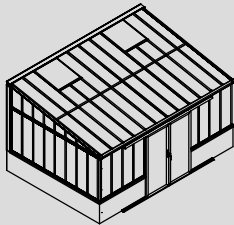
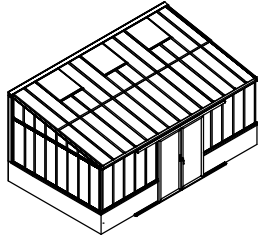
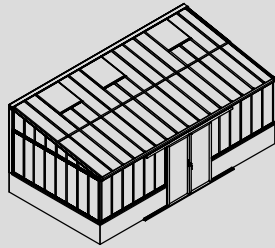
3281	3282	3283	3284	3285
				



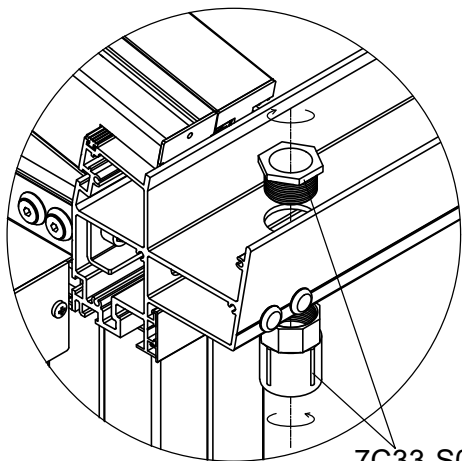
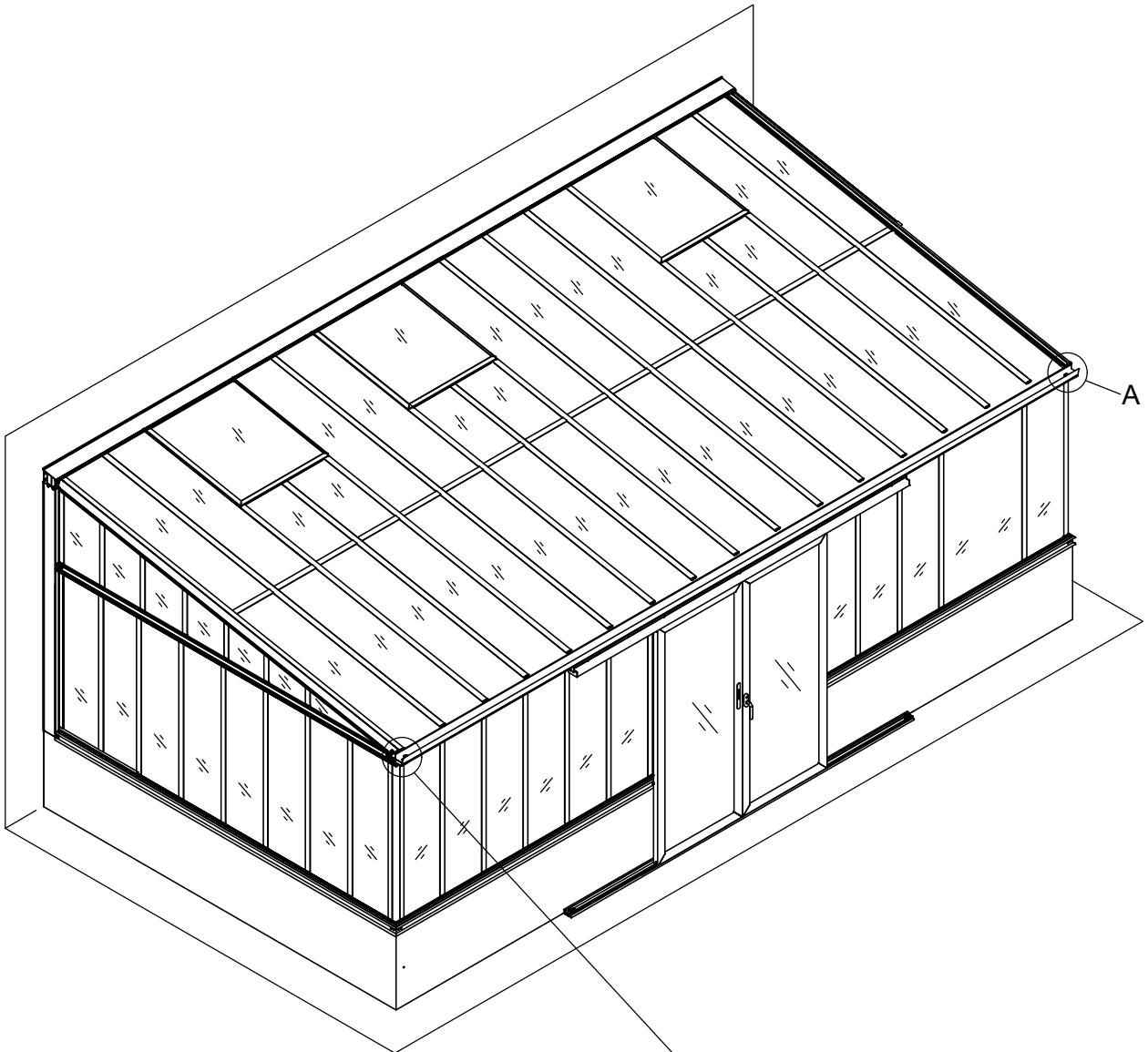

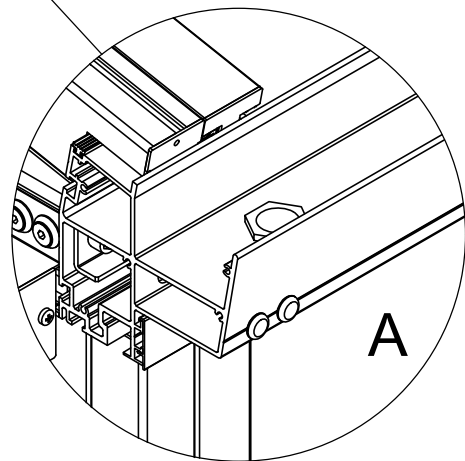
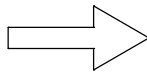

Part	NO.	QTY.	Length(MM)
	7C33-S02	2	PCS







7C33-S02

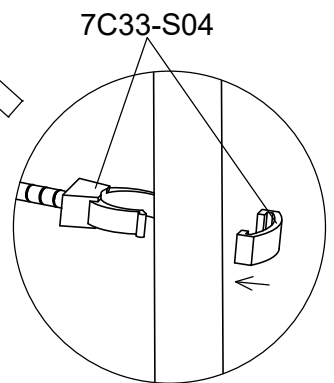
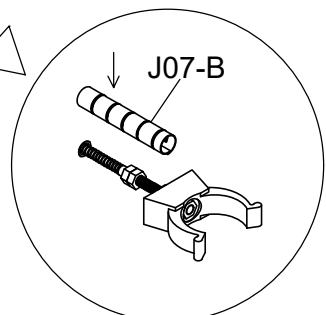
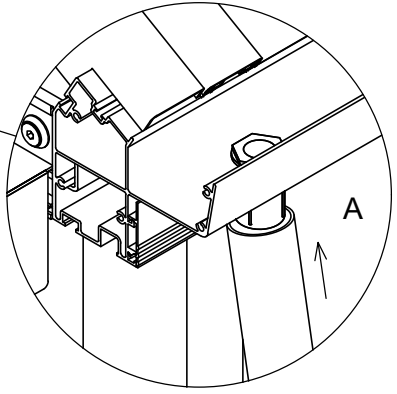
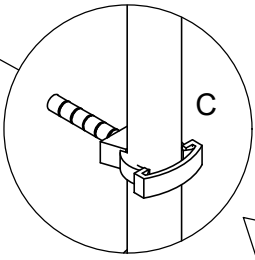
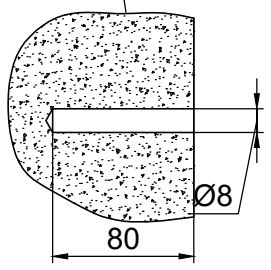
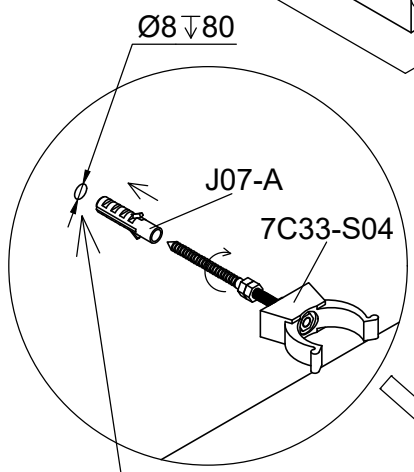
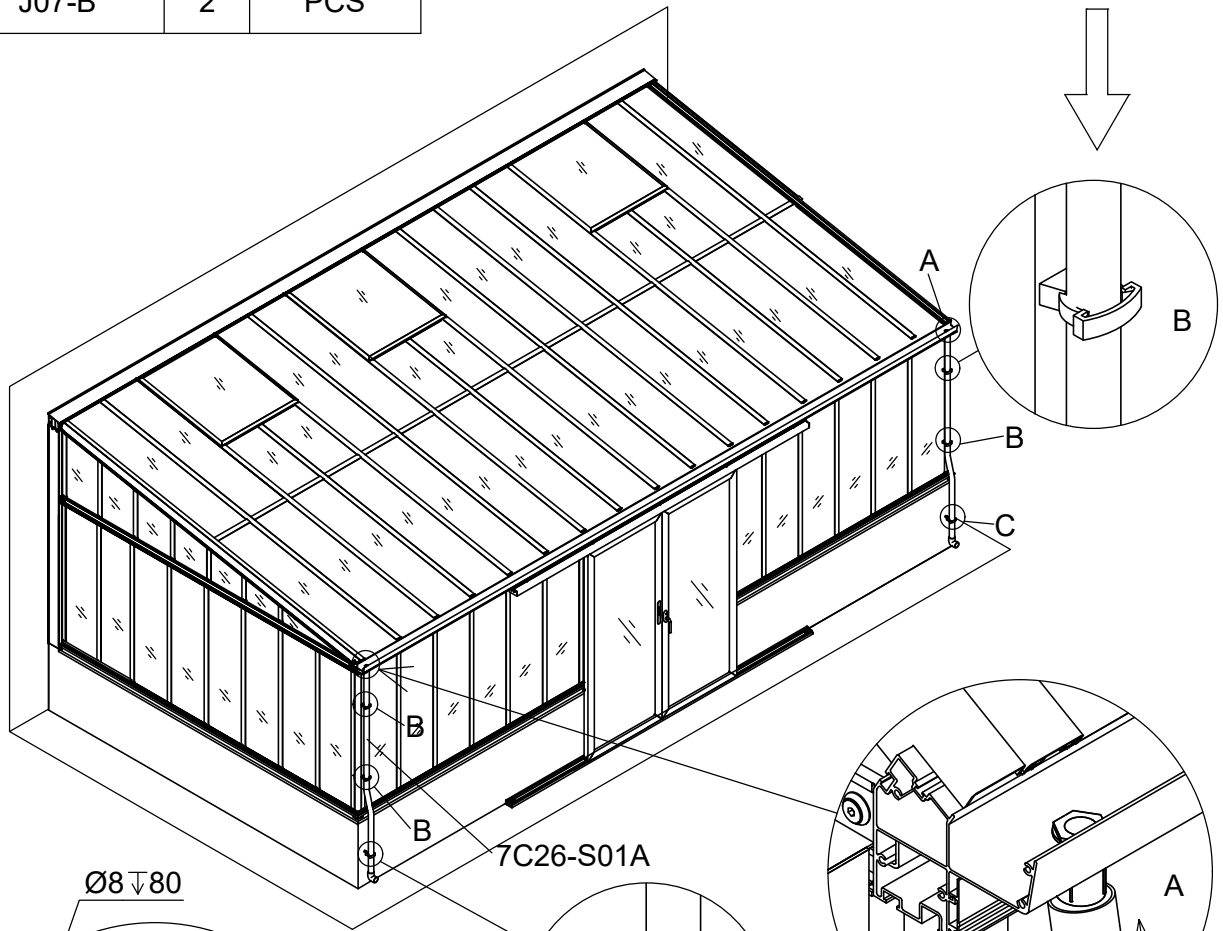
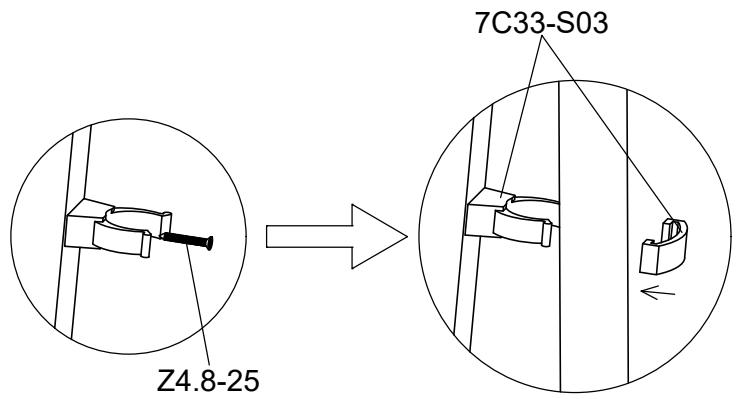

A





Part	NO.	QTY.	Length(MM)
	7C26-S01A	2	1900
	7C33-S03	4	PCS
	Z4.8-25	4	PCS
	7C33-S04	2	PCS
	J07-A	2	PCS
	J07-B	2	PCS

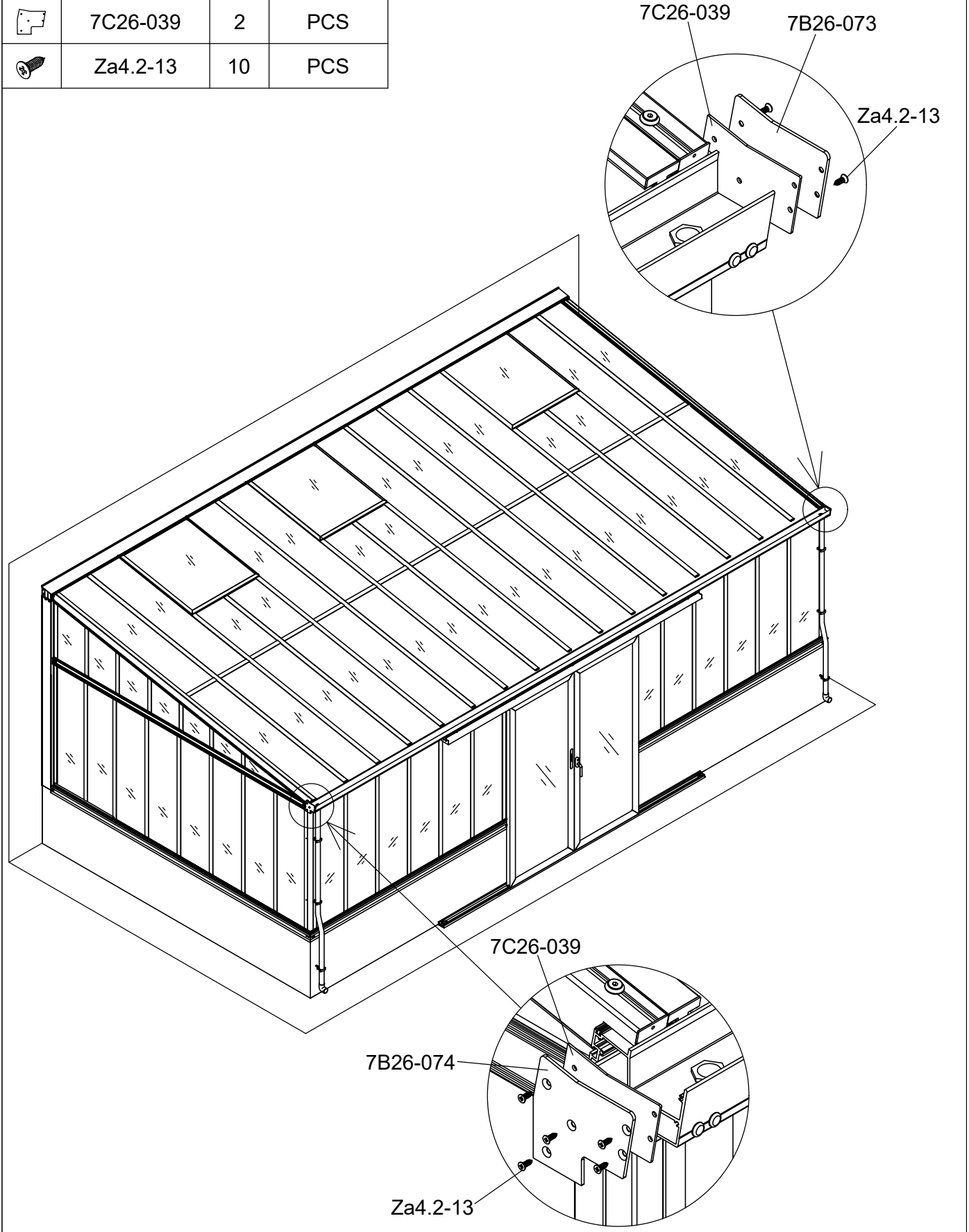

Part	NO.	QTY.	Length(MM)
	7B26-074	1	PCS
	7B26-073	1	PCS
	7C26-039	2	PCS
	Za4.2-13	10	PCS



30a/30

Part	NO.	QTY.	Length(MM)
	7B26-076	1	PCS
	7B26-075	1	PCS
	7C26-040	2	PCS
	Za4.2-13	8	PCS

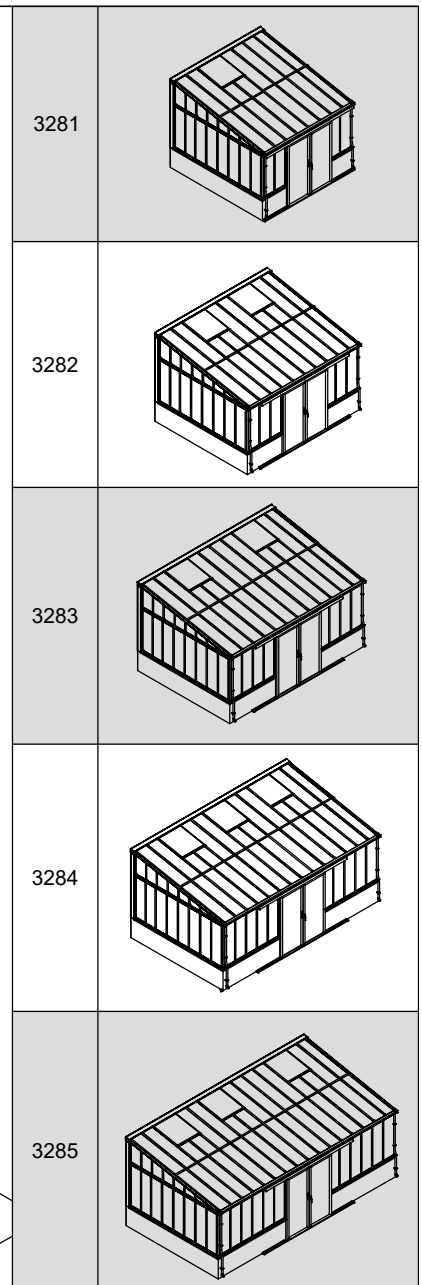
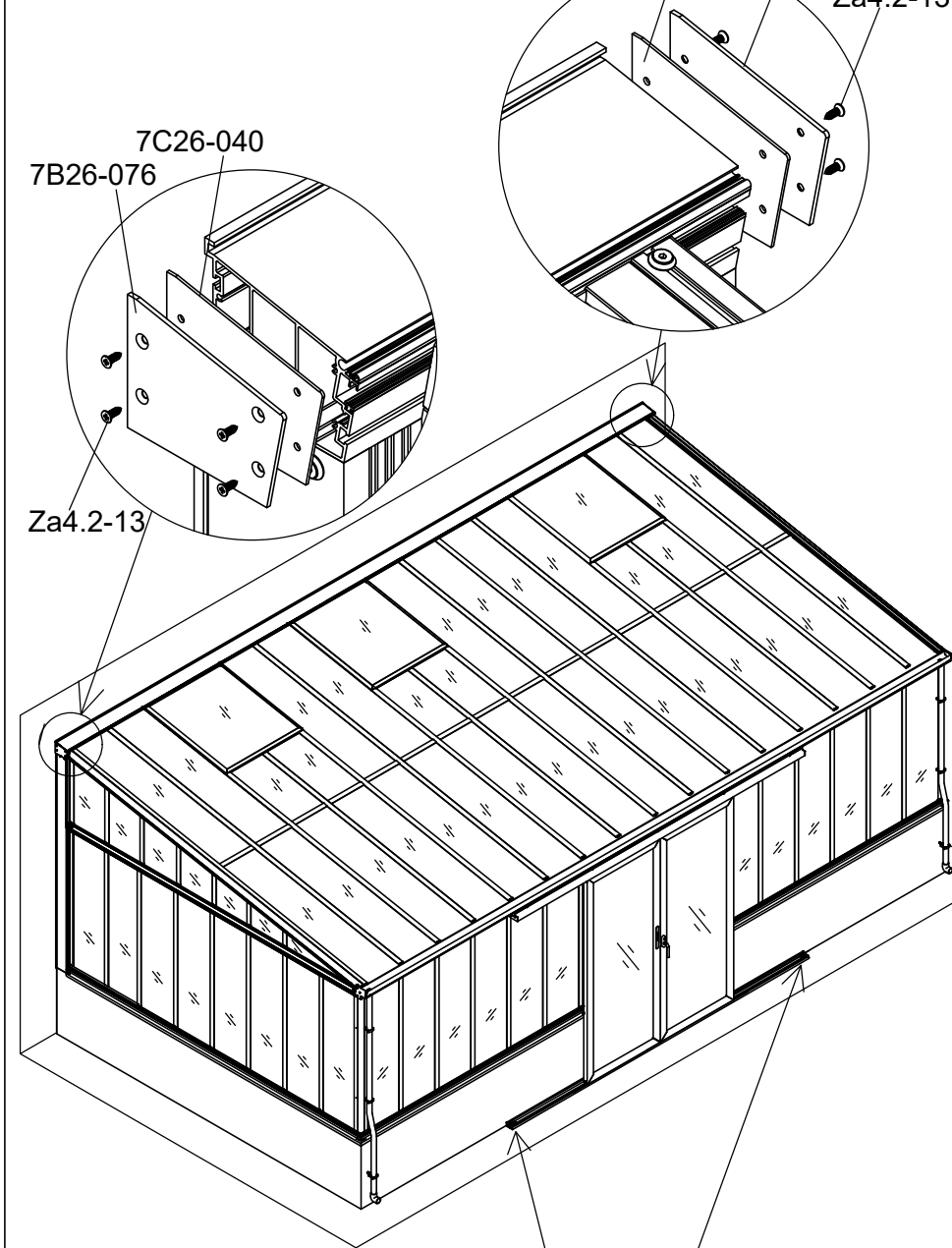

Adjust these door stoppers sideways if you want to open the door larger.
 Justera avståndet av dörrstoppen i sidled om ni vill kunna öppna dörrarna ännu mer.
 Justere dørstopperne sidelæns, for at give større åbning af døren.
 Juster avstanden av dørstopperen sideveis om du vil kunne åpne døren ennå mer.
 Säädä liukuovien stoppareiden etäisyys sivusuunnassa, mikäli haluat ovien avautuvan enemmän.

Part	Product	NO.	Length(MM)	CTN NO.	Code
	3281	40A-Y13R	854	3043PA-S-4	A009
	3282	50A-Y13R	1230	3171P-S-5D	
	3283	40A-S11-6R	1605	3171P-S-6D	
	3284	40A-S11-7R	1981	3171P-S-7D	
	3285	40A-S11-8R	2356	3171P-S-8D	A010
	3281	40A-Y13L	854	3043PA-S-4	
	3282	50A-Y13L	1230	3171P-S-5D	
	3283	40A-S11-6L	1605	3171P-S-6D	
	3284	40A-S11-7L	1981	3171P-S-7D	
	3285	40A-S11-8L	2356	3171P-S-8D	

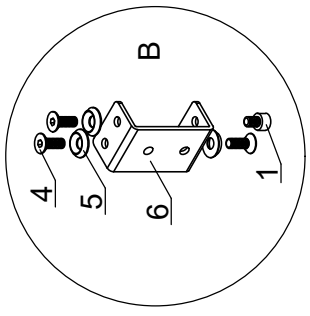
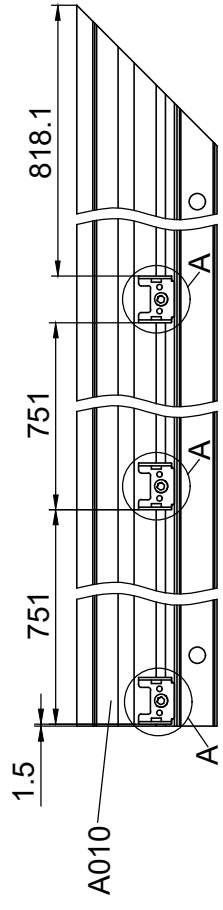
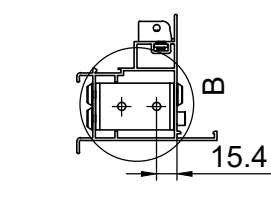
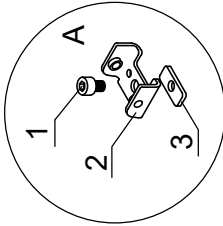
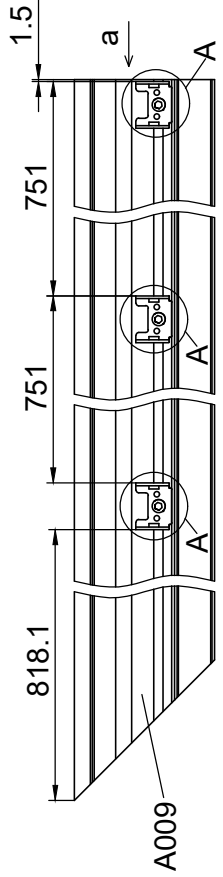
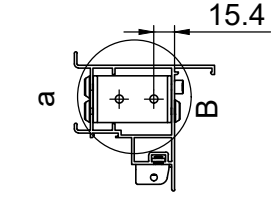

NO.	
1	M6-8
2	7B26-011
3	7B26-025
4	M6-16
5	7B26-013
6	7B26-037A

F1

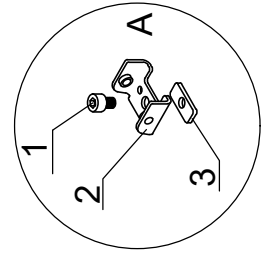
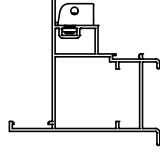
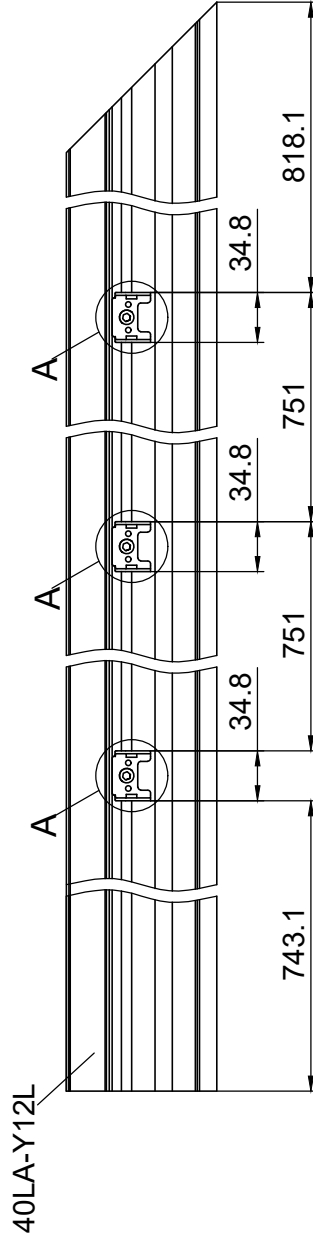
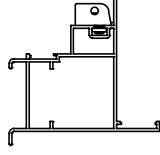
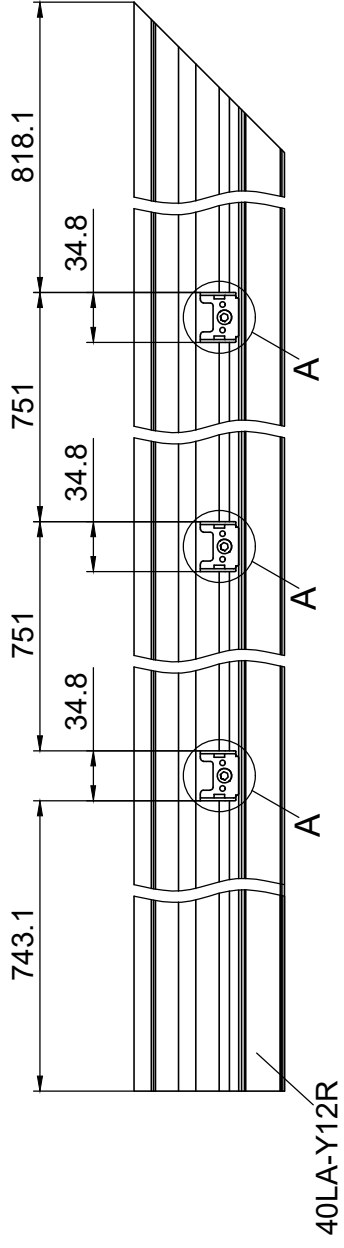

	NO.
1	M6-8
2	7B26-011
3	7B26-025

F2



1334

7.8

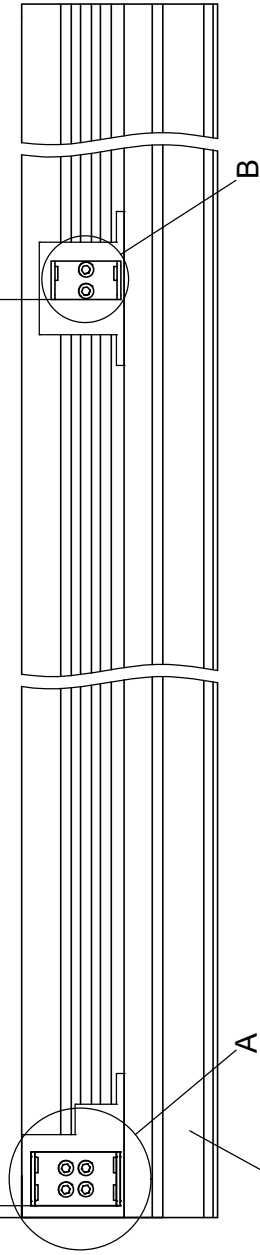

40LA-Y20L-11

1334

7.8

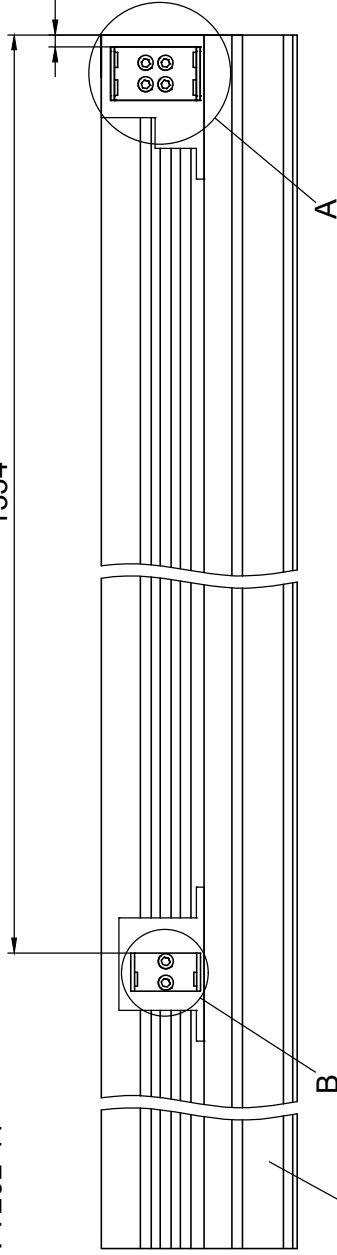

40LA-Y20R-11

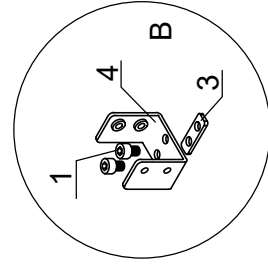
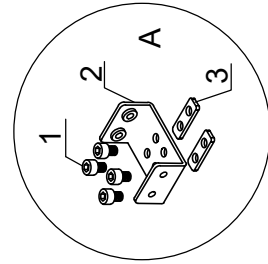
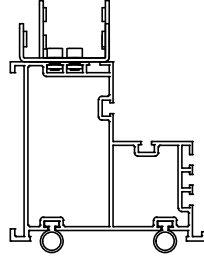
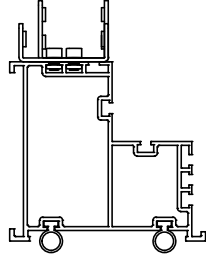

NO.	
1	M6-10
2	7B26-082
3	7B26-033
4	7B26-057

F3

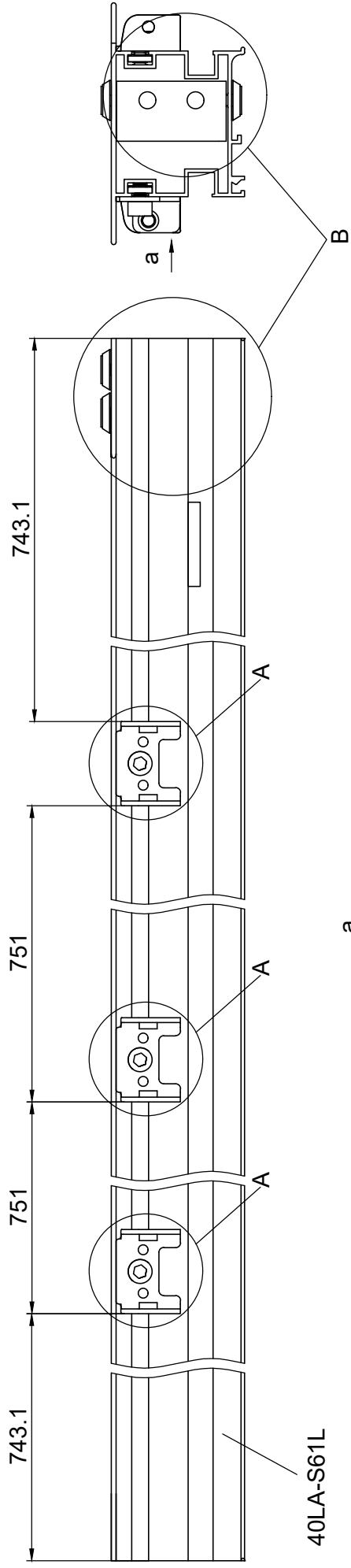

40LA-S61L

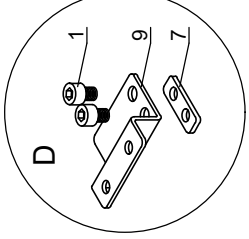
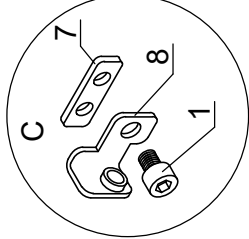
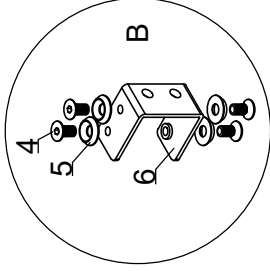
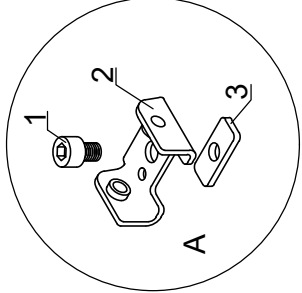
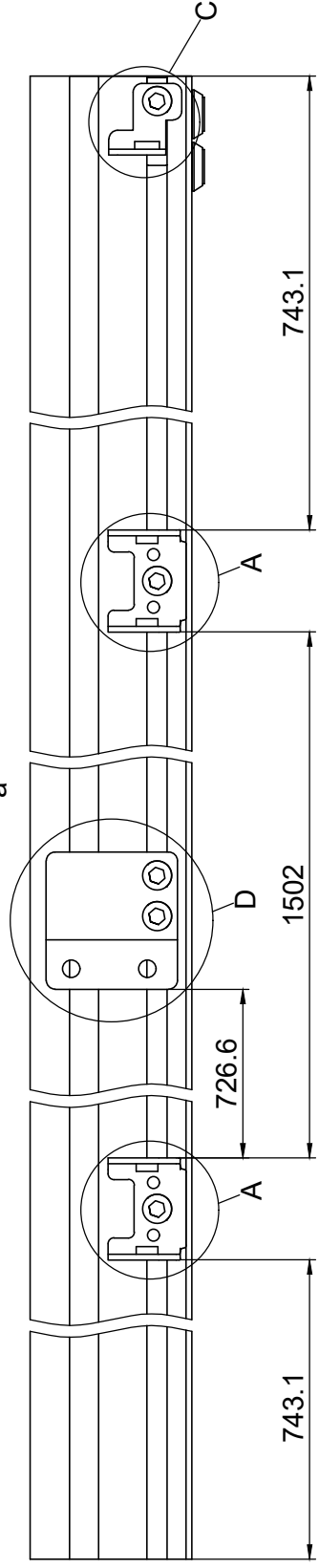

NO.	
1	M6-8
2	7B26-011
3	7B26-025
4	Si6-16
5	J05
6	7B26-056
7	7B26-033
8	7B26-027
9	7B26-036

F4

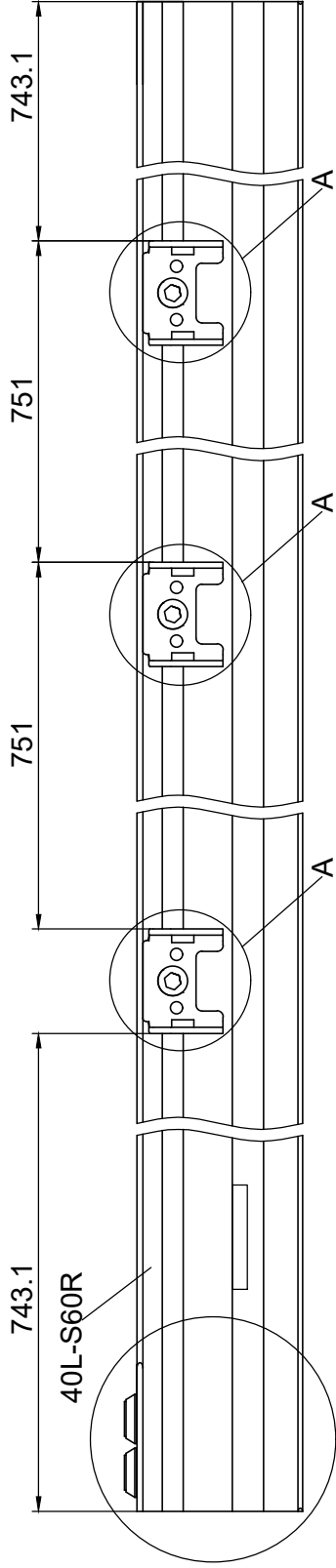

a

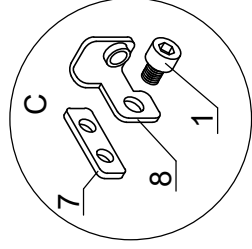
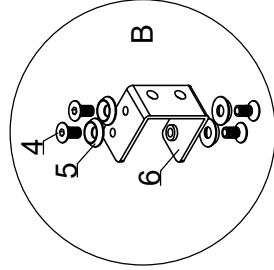
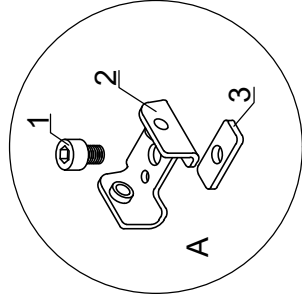
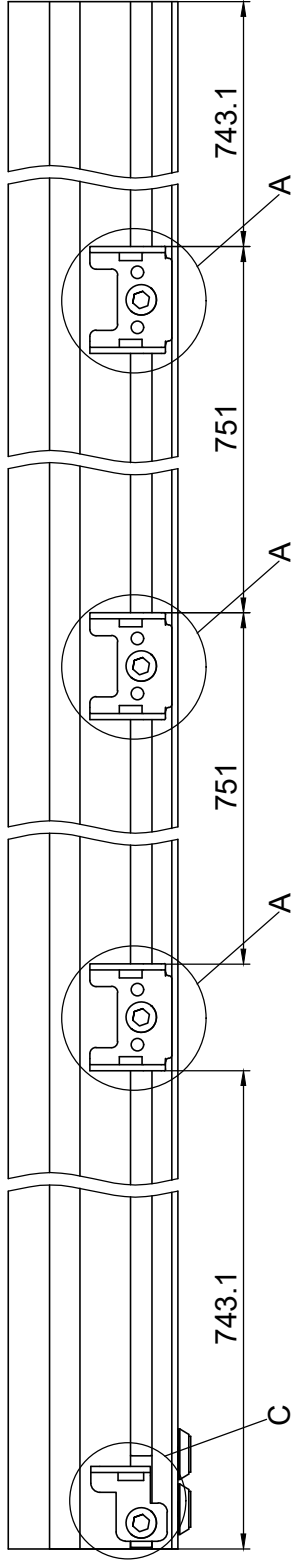

NO.	
1	M6-8
2	7B26-011
3	7B26-025
4	Si6-16
5	J05
6	7B26-056
7	7B26-033
8	7B26-026

F5

Part	Product	NO.	Length(MM)	Code
	3281	40L-Y62-4-11	3134	A003
	3282	40L-Y62-5-11	3885	
	3283	40L-Y62-6-11	4636	
	3284	40L-Y62-7-11	5387	
	3285	40L-Y62-8-11	6138	

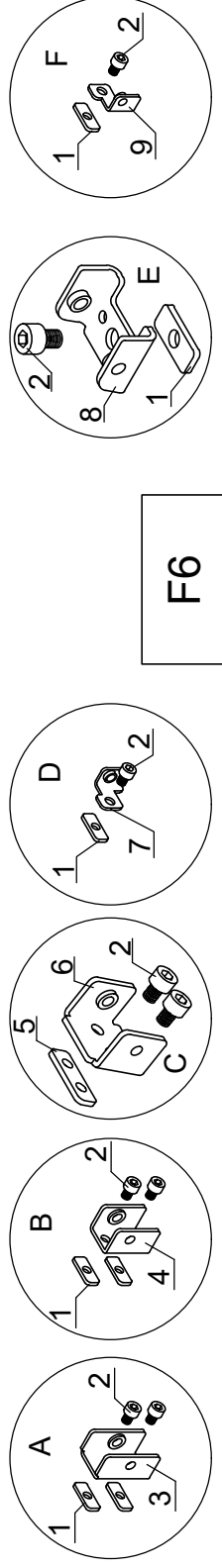
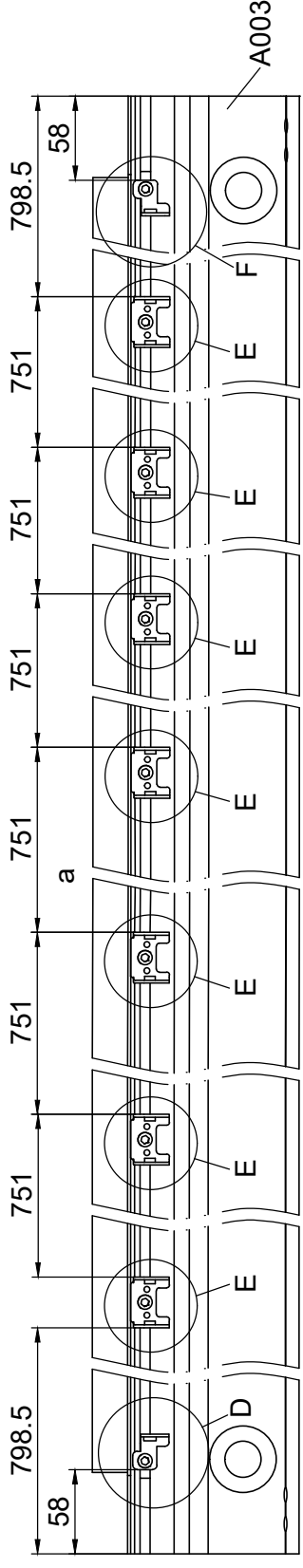
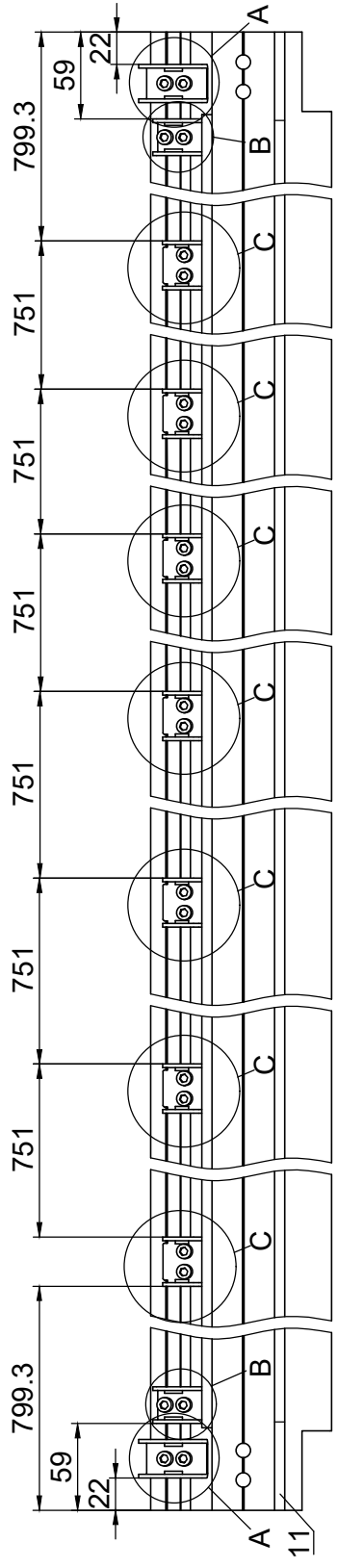
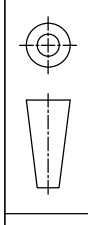

F6

	NO.
1	7B26-025
2	M6-8
3	7B26-086
4	7B26-087
5	7B26-033
6	7B26-062
7	7B26-027
8	7B26-011
9	7B26-026

Part	Product	NO.	Length(MM)	Code
	3281	40LA-Y63-4-11	3157	A004
	3282	40LA-Y63-5-11	3908	
	3283	40LA-Y63-6-11	4659	
	3284	40LA-Y63-7-11	5410	
	3285	40LA-Y63-8-11	6161	

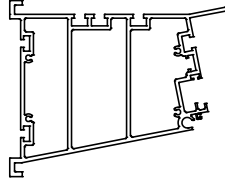
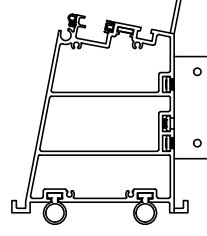
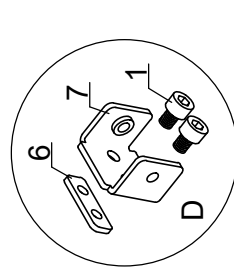
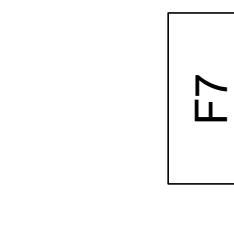
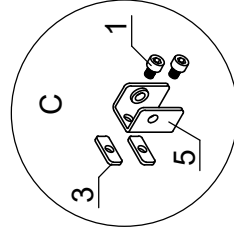
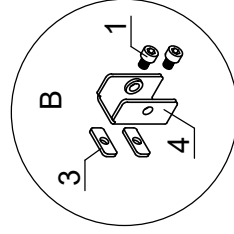
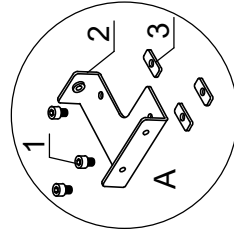
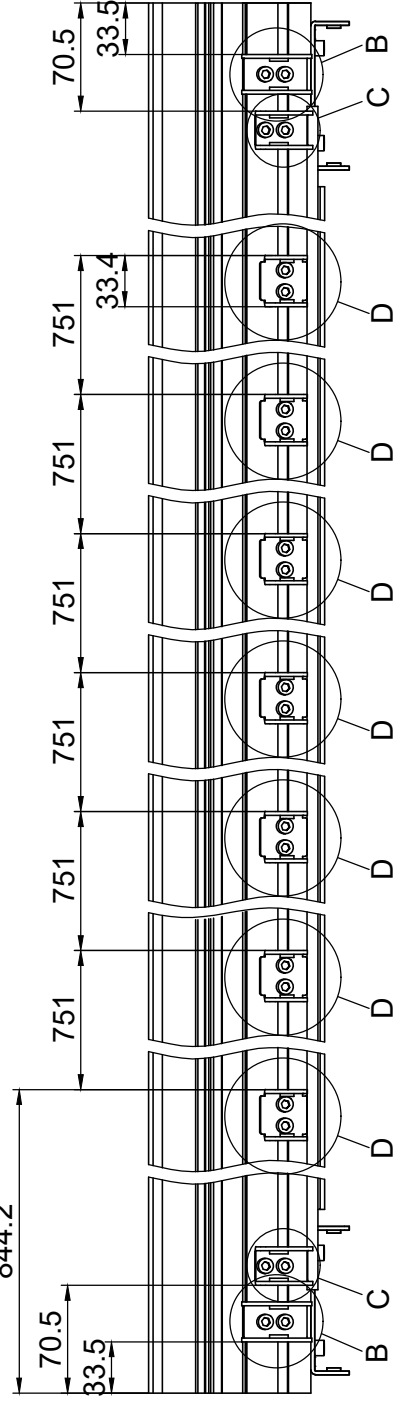
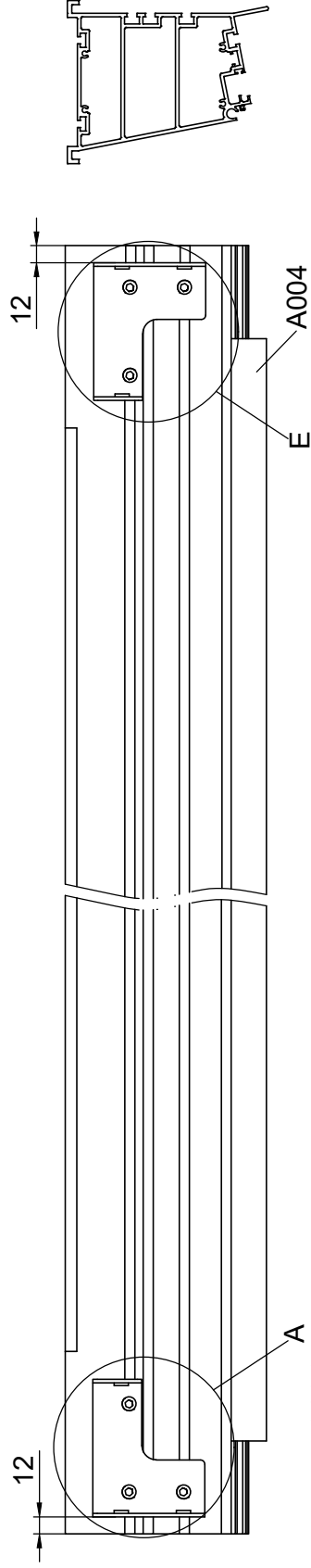
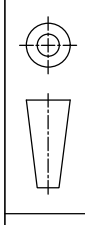

NO.	
1	M6-10
2	7B26-081
3	7B26-025
4	7B26-087
5	7B26-086
6	7B26-033
7	7B26-062
8	7B26-080

F7

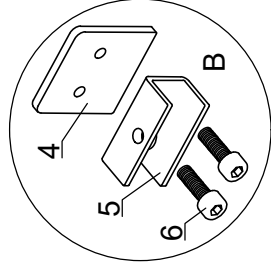
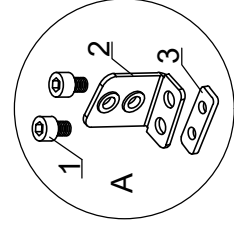
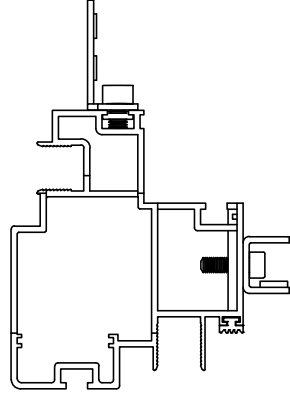
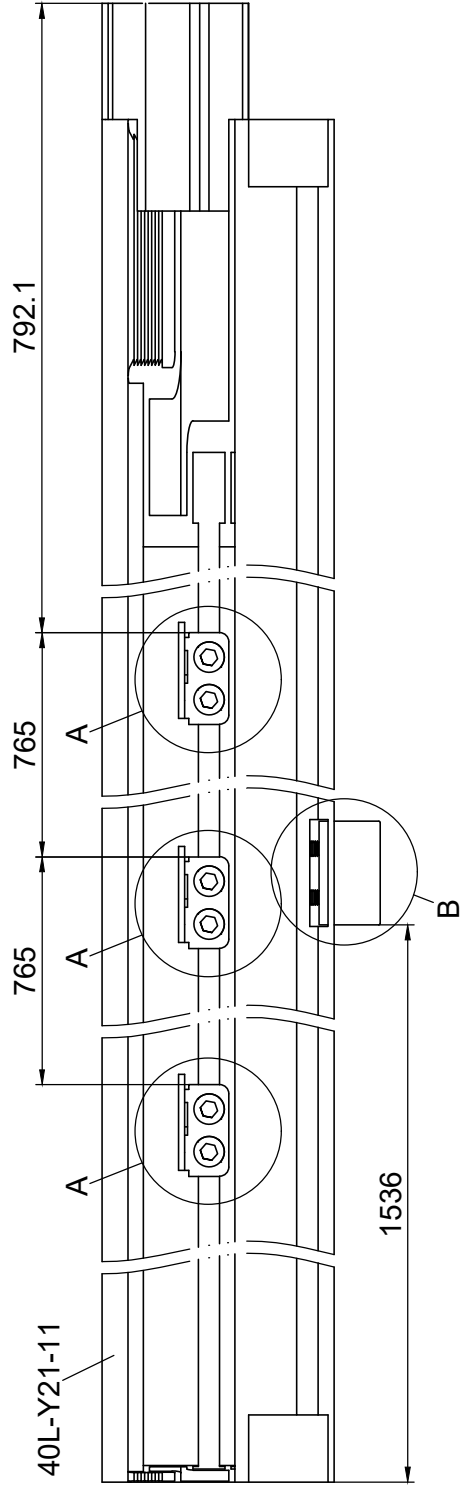

NO.	
1	M6-8
2	7B26-046R
3	7B26-033
4	7B26-079
5	7B26-078
6	Si5-16

F8

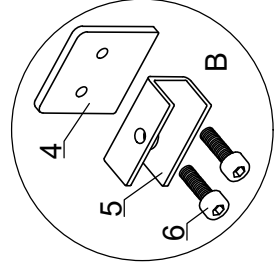
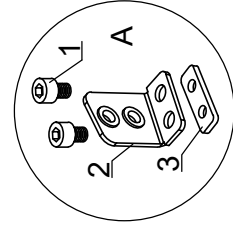
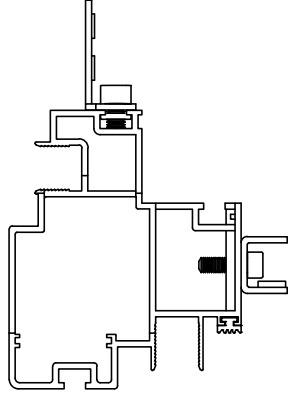
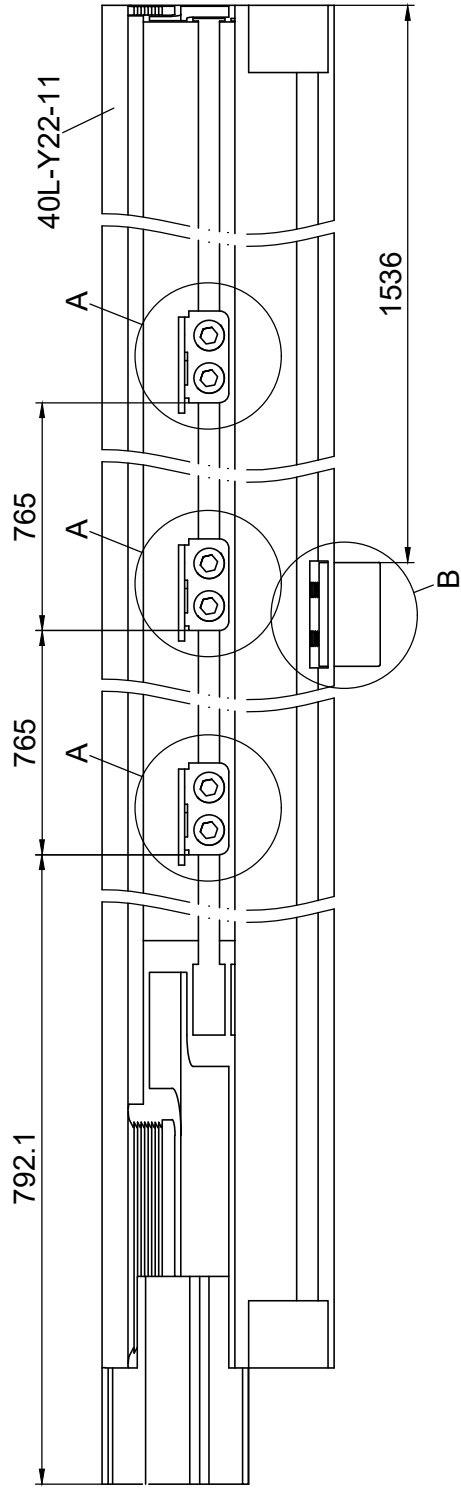

NO.	
1	M6-8
2	7B26-046L
3	7B26-033
4	7B26-079
5	7B26-078
6	Si5-16

F9

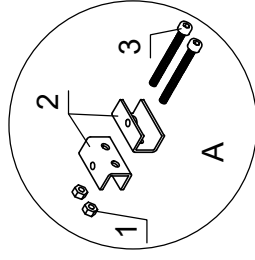
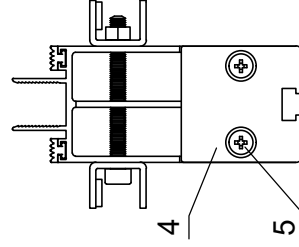
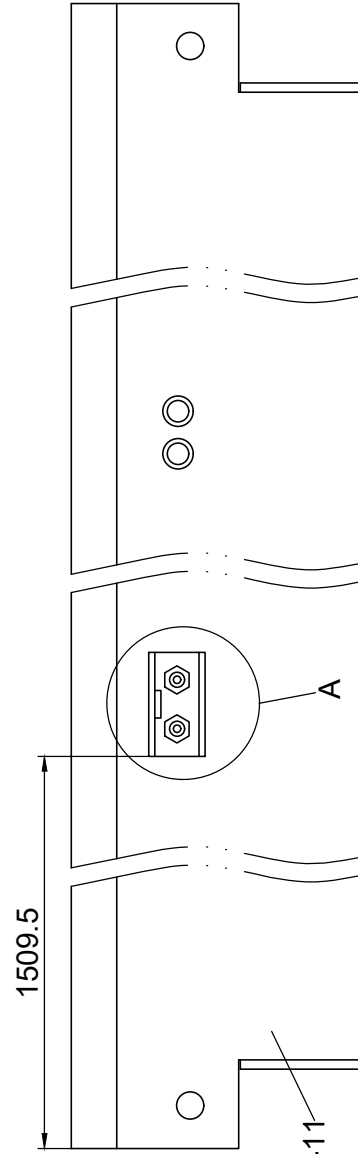
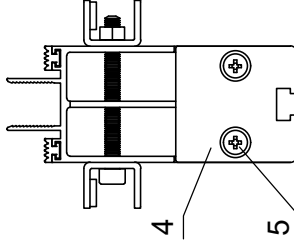
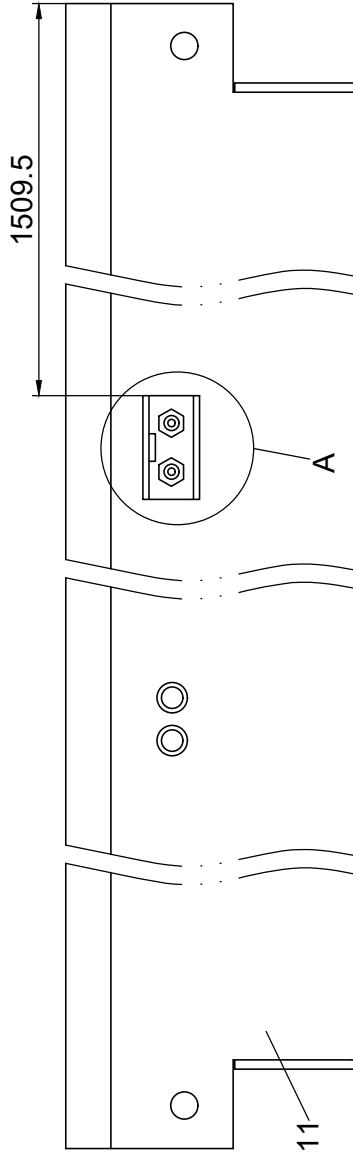
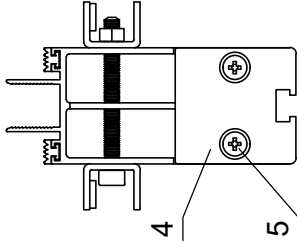
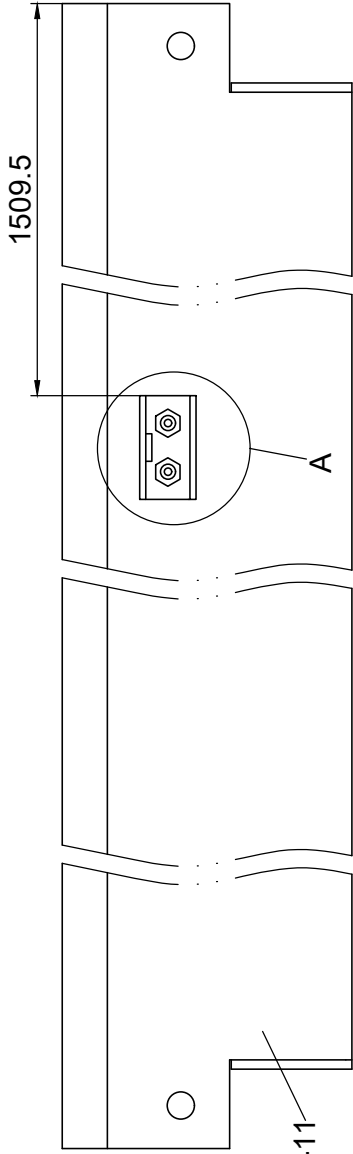

NO.	
1	M5
2	7B26-078
3	M5-50
4	7B26-071
5	Za4.2-13

F10